

# Dell G3 15

## Service Manual



## Notes, cautions, and warnings

 | **NOTE:** A NOTE indicates important information that helps you make better use of your product.

 | **CAUTION:** A CAUTION indicates either potential damage to hardware or loss of data and tells you how to avoid the problem.

 | **WARNING:** A WARNING indicates a potential for property damage, personal injury, or death.

© 2018 Dell Inc. or its subsidiaries. All rights reserved. Dell, EMC, and other trademarks are trademarks of Dell Inc. or its subsidiaries. Other trademarks may be trademarks of their respective owners.

# Contents

<b>1 Before working inside your computer</b> .....	<b>9</b>
Before you begin .....	9
Safety instructions.....	9
Recommended tools.....	9
Screw list.....	10
<b>2 After working inside your computer</b> .....	<b>12</b>
<b>3 Removing the base cover</b> .....	<b>13</b>
Procedure.....	13
<b>4 Replacing the base cover</b> .....	<b>16</b>
Procedure .....	16
<b>5 Removing the battery</b> .....	<b>19</b>
Prerequisites.....	19
Procedure.....	19
<b>6 Replacing the battery</b> .....	<b>20</b>
Procedure .....	20
Post-requisites.....	20
<b>7 Removing the memory modules</b> .....	<b>21</b>
Prerequisites.....	21
Procedure.....	21
<b>8 Replacing the memory modules</b> .....	<b>22</b>
Procedure .....	22
Post-requisites.....	22
<b>9 Removing the wireless card</b> .....	<b>23</b>
Prerequisites.....	23
Procedure.....	23
<b>10 Replacing the wireless card</b> .....	<b>25</b>
Procedure.....	25
Post-requisites.....	25
<b>11 Removing the coin-cell battery</b> .....	<b>26</b>
Prerequisites.....	26
Procedure.....	26
<b>12 Replacing the coin-cell battery</b> .....	<b>27</b>
Procedure.....	27

Post-requisites.....	27
<b>13 Removing the fan.....</b>	<b>28</b>
Prerequisites.....	28
Procedure.....	28
<b>14 Replacing the fan.....</b>	<b>30</b>
Procedure .....	30
Post-requisites.....	31
<b>15 Removing the processor fan.....</b>	<b>32</b>
Prerequisites.....	32
Procedure.....	32
<b>16 Replacing the processor fan.....</b>	<b>33</b>
Procedure.....	33
Post-requisites.....	33
<b>17 Removing the solid-state drive/Intel Optane.....</b>	<b>34</b>
Prerequisites.....	34
Procedure.....	34
<b>18 Replacing the solid-state drive/Intel Optane.....</b>	<b>35</b>
Procedure .....	35
Post-requisites.....	35
<b>19 Removing the hard drive.....</b>	<b>36</b>
Prerequisites.....	36
Procedure.....	36
<b>20 Replacing the hard drive.....</b>	<b>38</b>
Procedure .....	38
Post-requisites.....	39
<b>21 Removing the touchpad.....</b>	<b>40</b>
Prerequisites.....	40
Procedure.....	40
<b>22 Replacing the touchpad.....</b>	<b>41</b>
Procedure .....	41
Post-requisites.....	41
<b>23 Removing the power-adapter port.....</b>	<b>42</b>
Prerequisites.....	42
Procedure.....	42
<b>24 Replacing the power-adapter port.....</b>	<b>43</b>
Procedure .....	43



Post-requisites.....	43
<b>25 Removing the speakers.....</b>	<b>44</b>
Prerequisites.....	44
Procedure.....	44
<b>26 Replacing the speakers.....</b>	<b>45</b>
Procedure .....	45
Post-requisites.....	45
<b>27 Removing the heat sink.....</b>	<b>46</b>
Prerequisites.....	46
Procedure.....	46
<b>28 Replacing the heat sink.....</b>	<b>47</b>
Procedure .....	47
Post-requisites.....	47
<b>29 Removing the display assembly.....</b>	<b>48</b>
Prerequisites.....	48
Procedure.....	48
<b>30 Replacing the display assembly.....</b>	<b>51</b>
Procedure .....	51
Post-requisites.....	53
<b>31 Removing the I/O board.....</b>	<b>54</b>
Prerequisites.....	54
Procedure.....	54
<b>32 Replacing the I/O board.....</b>	<b>55</b>
Procedure .....	55
Post-requisites.....	55
<b>33 Removing the power-button board.....</b>	<b>56</b>
Prerequisites.....	56
Procedure.....	56
<b>34 Replacing the power-button board.....</b>	<b>58</b>
Procedure .....	58
Post-requisites.....	59
<b>35 Removing the system board.....</b>	<b>60</b>
Prerequisites.....	60
Procedure.....	60
<b>36 Replacing the system board.....</b>	<b>63</b>
Procedure .....	63

Post-requisites.....	64
Entering the Service Tag in the BIOS setup program.....	65
<b>37 Removing the power button with fingerprint reader.....</b>	<b>66</b>
Prerequisites.....	66
Procedure.....	66
<b>38 Replacing the power button with fingerprint reader.....</b>	<b>68</b>
Procedure .....	68
Post-requisites.....	68
<b>39 Removing the palm-rest and keyboard assembly.....</b>	<b>70</b>
Prerequisites.....	70
Procedure.....	70
<b>40 Replacing the palm-rest and keyboard assembly.....</b>	<b>72</b>
Procedure .....	72
Post-requisites.....	72
<b>41 Removing the display bezel.....</b>	<b>73</b>
Prerequisites.....	73
Procedure.....	73
<b>42 Replacing the display bezel.....</b>	<b>74</b>
Procedure .....	74
Post-requisites.....	74
<b>43 Removing the camera.....</b>	<b>75</b>
Prerequisites.....	75
Procedure.....	75
<b>44 Replacing the camera.....</b>	<b>76</b>
Procedure .....	76
Post-requisites.....	76
<b>45 Removing the display panel.....</b>	<b>77</b>
Prerequisites.....	77
Procedure.....	77
<b>46 Replacing the display panel.....</b>	<b>79</b>
Procedure .....	79
Post-requisites.....	80
<b>47 Removing the display hinges.....</b>	<b>81</b>
Prerequisites.....	81
Procedure.....	81
<b>48 Replacing the display hinges.....</b>	<b>82</b>

Procedure .....	82
Post-requisites.....	82
<b>49 Removing the display cable.....</b>	<b>83</b>
Prerequisites.....	83
Procedure.....	83
<b>50 Replacing the display cable.....</b>	<b>84</b>
Procedure .....	84
Post-requisites.....	84
<b>51 Removing the display back-cover and antenna assembly.....</b>	<b>85</b>
Prerequisites.....	85
Procedure.....	85
<b>52 Replacing the display back-cover and antenna assembly.....</b>	<b>86</b>
Procedure .....	86
Post-requisites.....	86
<b>53 Downloading drivers.....</b>	<b>87</b>
Downloading the audio driver.....	87
Downloading the graphics driver.....	87
Downloading the USB 3.0 driver.....	87
Downloading the Wi-Fi driver.....	88
Downloading the media-card reader driver.....	88
Downloading the chipset driver.....	88
Downloading the network driver.....	88
<b>54 System setup.....</b>	<b>90</b>
Boot Sequence.....	90
Navigation keys.....	90
BIOS overview.....	91
Entering BIOS setup program.....	91
Enabling or disabling the USB in BIOS setup program.....	91
Identifying the hard drive in BIOS setup program.....	91
Checking the system memory in BIOS setup program.....	91
System setup options.....	91
<b>55 System and setup password.....</b>	<b>97</b>
Assigning a system password and setup password.....	97
Deleting or changing an existing system setup password.....	97
Clearing CMOS settings.....	98
Clearing forgotten passwords.....	98
<b>56 Troubleshooting.....</b>	<b>99</b>
Flashing the BIOS.....	99
Flashing BIOS (USB key).....	99
Intel Optane memory (Optional).....	99

Enabling Intel Optane memory.....	99
Disabling Intel Optane memory.....	100
Reinstall Windows using a USB recovery drive.....	100
Enhanced Pre-Boot System Assessment (ePSA) diagnostics.....	100
Running the ePSA diagnostics.....	101
System diagnostic lights.....	101
Wi-Fi power cycle.....	102
Flea power release.....	102
<b>57 Getting help and contacting Dell.....</b>	<b>104</b>
Self-help resources.....	104
Contacting Dell.....	104

# Before working inside your computer

 **NOTE:** The images in this document may differ from your computer depending on the configuration you ordered.

## Before you begin









- 1 Save and close all open files and exit all open applications.
- 2 Shut down your computer. Click **Start** >  **Power** > **Shut down**.

 **NOTE:** If you are using a different operating system, see the documentation of your operating system for shut-down instructions.

- 3 Disconnect your computer and all attached devices from their electrical outlets.
- 4 Disconnect all attached network devices and peripherals, such as keyboard, mouse, and monitor from your computer.
- 5 Remove any media card and optical disc from your computer, if applicable.

## Safety instructions

Use the following safety guidelines to protect your computer from potential damage and ensure your personal safety.

-  **WARNING:** Before working inside your computer, read the safety information that shipped with your computer. For more safety best practices, see the Regulatory Compliance home page at [www.dell.com/regulatory\\_compliance](http://www.dell.com/regulatory_compliance).
-  **WARNING:** Disconnect all power sources before opening the computer cover or panels. After you finish working inside the computer, replace all covers, panels, and screws before connecting to the electrical outlet.
-  **CAUTION:** To avoid damaging the computer, ensure that the work surface is flat and clean.
-  **CAUTION:** To avoid damaging the components and cards, handle them by their edges, and avoid touching pins and contacts.
-  **CAUTION:** You should only perform troubleshooting and repairs as authorized or directed by the Dell technical assistance team. Damage due to servicing that is not authorized by Dell is not covered by your warranty. See the safety instructions that shipped with the product or at [www.dell.com/regulatory\\_compliance](http://www.dell.com/regulatory_compliance).
-  **CAUTION:** Before touching anything inside your computer, ground yourself by touching an unpainted metal surface, such as the metal at the back of the computer. While you work, periodically touch an unpainted metal surface to dissipate static electricity, which could harm internal components.
-  **CAUTION:** When you disconnect a cable, pull on its connector or on its pull tab, not on the cable itself. Some cables have connectors with locking tabs or thumb-screws that you must disengage before disconnecting the cable. When disconnecting cables, keep them evenly aligned to avoid bending any connector pins. When connecting cables, ensure that the ports and connectors are correctly oriented and aligned.
-  **CAUTION:** Press and eject any installed card from the media-card reader.

















## Recommended tools



The procedures in this document may require the following tools:

- Phillips screwdriver #1
- Plastic scribe

# Screw list

**Table 1. Screw list**

Component	Secured to	Screw type	Quantity	Screw image
Base cover	Palm rest and keyboard assembly	M2.5x6	8	
Battery	Palm rest and keyboard assembly	M2x3	5	
Display panel	Display back-cover and antenna assembly	M2x3	4	
Fan	Palm rest and keyboard assembly	M2.5x6	2	
Processor fan	Palm rest and keyboard assembly	M2.5x6	2	
Hard-drive assembly	Palm rest and keyboard assembly	M2x3	2	
Hard-drive bracket	Hard drive	M3x3	4	
Heat sink	System board	M2x3	4	
<p><b>NOTE:</b> Applicable only for computers shipped with discrete configuration.</p>				
Hinges	Palm rest and keyboard assembly	M2.5x6	6	
Hinge brackets	Display back-cover and antenna assembly	M2.5x2.5	8	
Hinge brackets	Display back-cover and antenna assembly	M2x2	2	
I/O board	Palm rest and keyboard assembly	M2.5x2.5	2	
Power-adapter port	Palm rest and keyboard assembly	M2x2	1	
Power-button board	Palm rest and keyboard assembly	M2x2	1	
Power button with fingerprint reader (optional)	Palm rest and keyboard assembly	M2x2	1	
Solid-state drive	Palm rest and keyboard assembly	M2x3	1	
<p><b>NOTE:</b> Applicable for computers shipped with M.2 SATA solid-state drive.</p>				

<b>Component</b>	<b>Secured to</b>	<b>Screw type</b>	<b>Quantity</b>	<b>Screw image</b>
System board	Palm rest and keyboard assembly	M2.5x2.5	3	
Touchpad	Touchpad and palm rest	M2x2	4	
Wireless-card bracket	System board	M2x3	1	

## After working inside your computer

 **CAUTION:** Leaving stray or loose screws inside your computer may severely damage your computer.

- 1 Replace all screws and ensure that no stray screws remain inside your computer.
- 2 Connect any external devices, peripherals, or cables you removed before working on your computer.
- 3 Replace any media cards, discs, or any other parts that you removed before working on your computer.
- 4 Connect your computer and all attached devices to their electrical outlets.
- 5 Turn on your computer.



## Removing the base cover

**⚠ WARNING:** Before working inside your computer, read the safety information that shipped with your computer and follow the steps in [Before working inside your computer](#). After working inside your computer, follow the instructions in [After working inside your computer](#). For more safety best practices, see the Regulatory Compliance home page at [www.dell.com/regulatory\\_compliance](http://www.dell.com/regulatory_compliance).

### Procedure

- 1 Remove the eight screws (M2.5x6) that secure the base cover to the palm rest and keyboard assembly.
- 2 Loosen the two captive screws (M2.5) on the base cover.

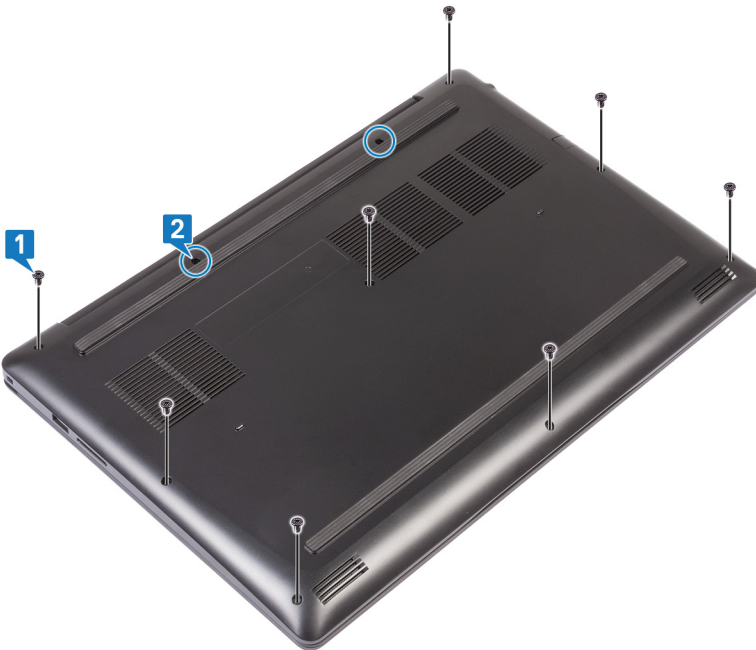

- 3 Pry the base cover starting from the left hinge.
- 4 Continue prying the base cover from the bottom of the computer base.

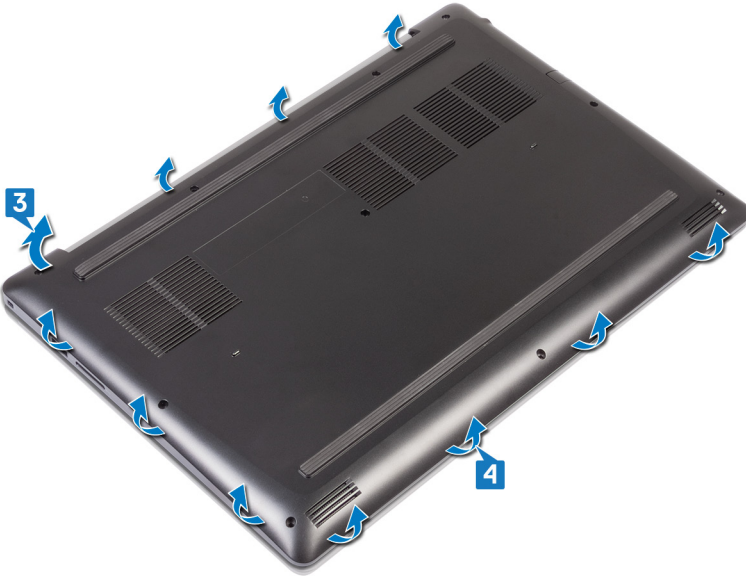

- 5 Pry the base cover from the right side and lift it off the palm rest and keyboard assembly.

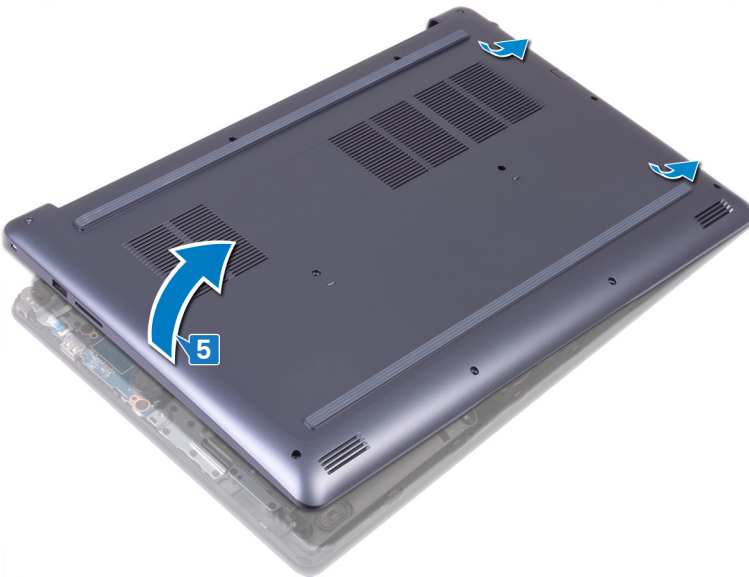

**NOTE:** The following steps are applicable only if you want to further remove any other component from your computer.

- 6 Peel the tape that secures the battery cable to the system board.
- 7 Disconnect the battery cable from the system board.

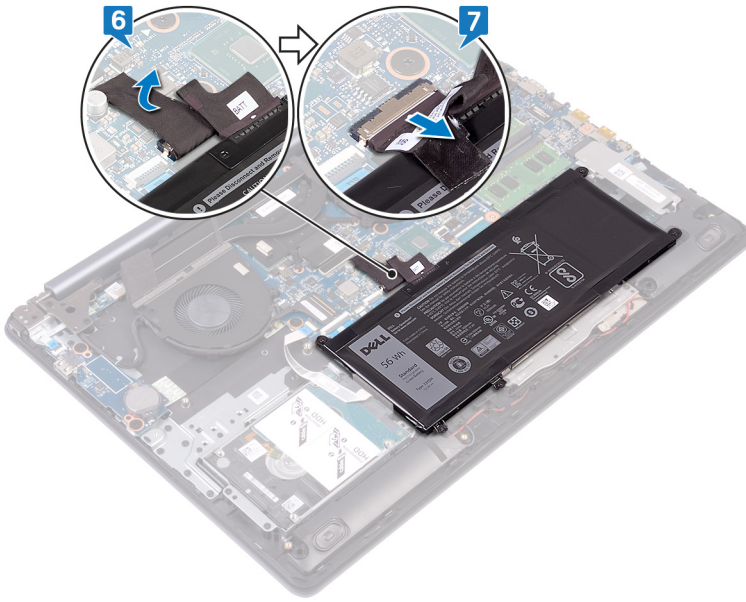

8 Press and hold the power button for 5 seconds to ground the computer and drain the flea power.

# Replacing the base cover

**WARNING:** Before working inside your computer, read the safety information that shipped with your computer and follow the steps in [Before working inside your computer](#). After working inside your computer, follow the instructions in [After working inside your computer](#). For more safety best practices, see the Regulatory Compliance home page at [www.dell.com/regulatory\\_compliance](http://www.dell.com/regulatory_compliance).

## Procedure

- 1 Connect the battery cable to the system board, if applicable.
- 2 Adhere the tape that secures the battery cable to the system board.

**CAUTION:** To avoid accidental damage to the power-adaptor port, do not press the base cover against the power-adaptor port when you snap the base cover to the computer base.

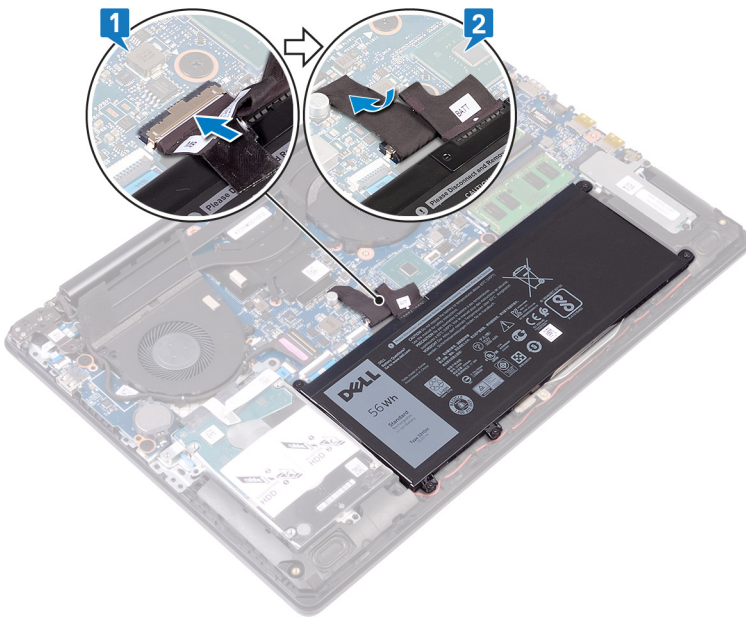

- 3 Place the base cover on the palm rest and keyboard assembly, and snap the base cover into place starting from the power-adaptor port.



- 4 Align the tabs on the base cover with the slots on the palm-rest assembly and snap it into place.

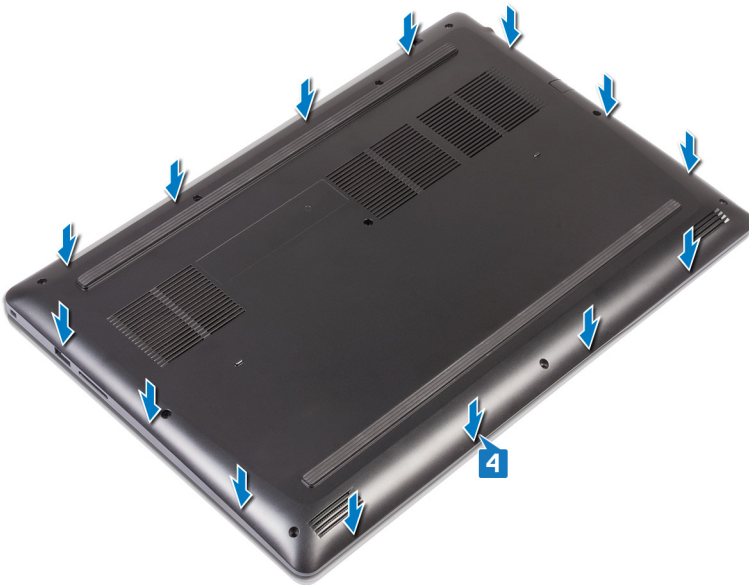

- 5 Tighten the two captive screws (M2.5) that secure the base cover to the palm rest and keyboard assembly.
- 6 Replace the eight screws (M2.5x6) that secure the base cover to the palm rest and keyboard assembly.

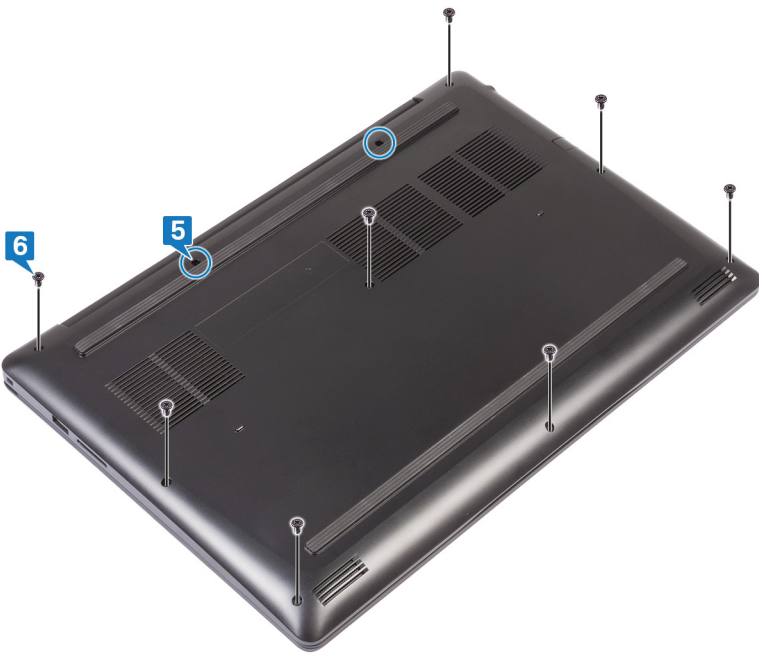

# Removing the battery

**⚠ WARNING:** Before working inside your computer, read the safety information that shipped with your computer and follow the steps in [Before working inside your computer](#). After working inside your computer, follow the instructions in [After working inside your computer](#). For more safety best practices, see the Regulatory Compliance home page at [www.dell.com/regulatory\\_compliance](http://www.dell.com/regulatory_compliance).

## Prerequisites

Remove the [base cover](#).

## Procedure

- 1 Remove the five screws (M2x3) that secure the battery to the palm rest and keyboard assembly.
- 2 Lift the battery off the palm rest and keyboard assembly.

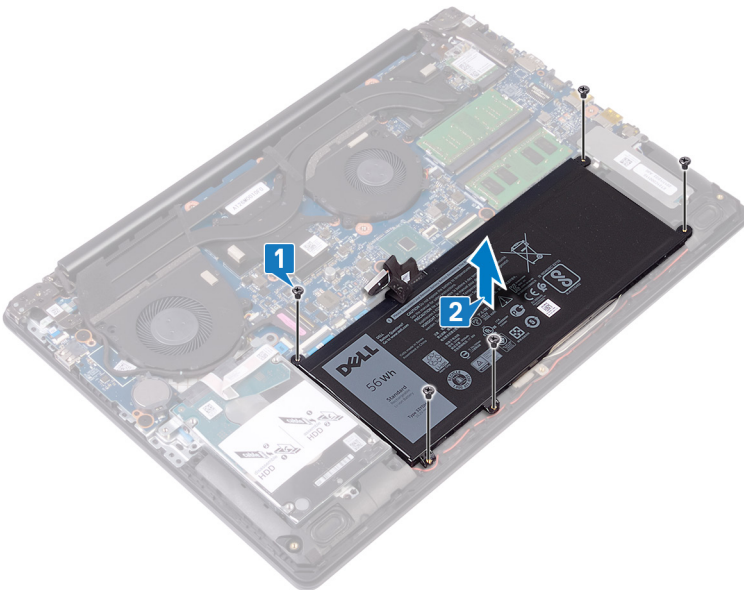



# Replacing the battery

**⚠ WARNING:** Before working inside your computer, read the safety information that shipped with your computer and follow the steps in [Before working inside your computer](#). After working inside your computer, follow the instructions in [After working inside your computer](#). For more safety best practices, see the Regulatory Compliance home page at [www.dell.com/regulatory\\_compliance](http://www.dell.com/regulatory_compliance).

## Procedure

- 1 Align the screw holes on the battery with the screw holes on the palm rest and keyboard assembly.
- 2 Replace the four screws (M2x3) that secure the battery to the palm rest and keyboard assembly.

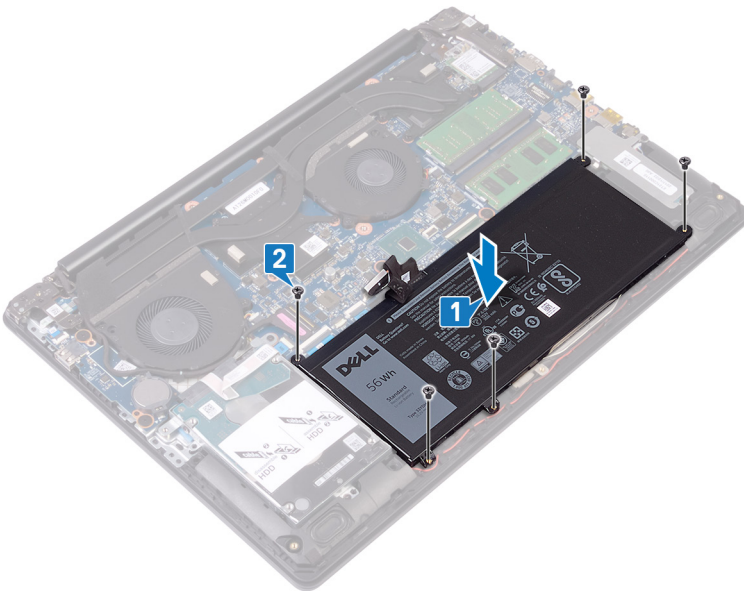

## Post-requisites

Replace the [base cover](#).



# Removing the memory modules

**⚠ WARNING:** Before working inside your computer, read the safety information that shipped with your computer and follow the steps in [Before working inside your computer](#). After working inside your computer, follow the instructions in [After working inside your computer](#). For more safety best practices, see the Regulatory Compliance home page at [www.dell.com/regulatory\\_compliance](http://www.dell.com/regulatory_compliance).

## Prerequisites

Remove the [base cover](#).

## Procedure

- 1 Locate the memory modules on your computer.

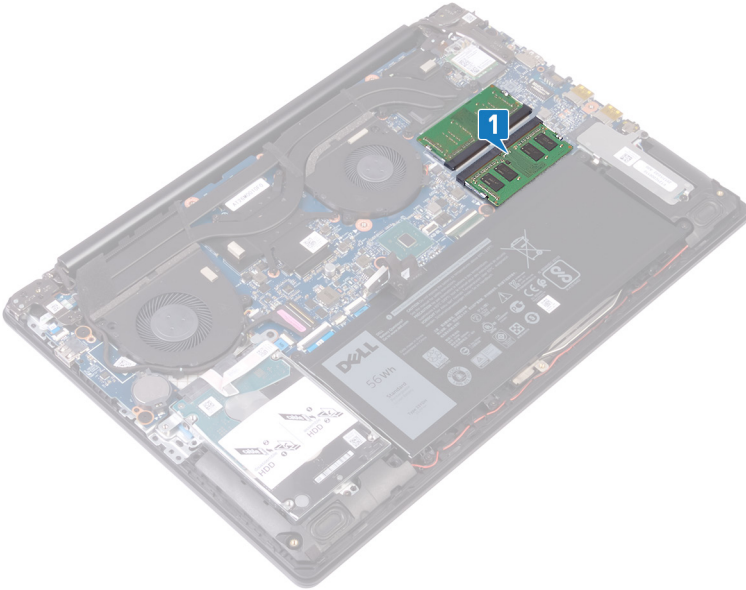

- 2 Use your fingertips to carefully spread apart the securing-clips on each end of the memory-module slot until the memory module pops up.
- 3 Remove the memory modules from the memory-module slot.

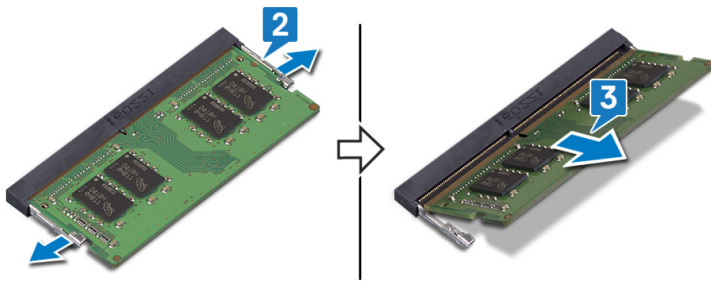

# Replacing the memory modules

**⚠ WARNING:** Before working inside your computer, read the safety information that shipped with your computer and follow the steps in [Before working inside your computer](#). After working inside your computer, follow the instructions in [After working inside your computer](#). For more safety best practices, see the Regulatory Compliance home page at [www.dell.com/regulatory\\_compliance](http://www.dell.com/regulatory_compliance).

## Procedure

- 1 Align the notch on the memory module with the tab on the memory-module slot.
- 2 Slide the memory modules firmly into the slot at an angle.
- 3 Press the memory module down until it clicks into place.

**🕒 NOTE:** If you do not hear the click, remove the memory module and reinstall it.

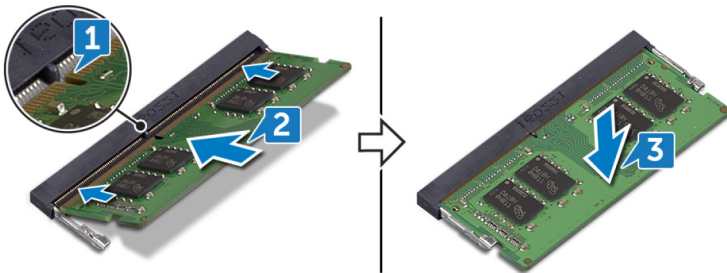

## Post-requisites

Replace the [base cover](#).

# Removing the wireless card

**⚠ WARNING:** Before working inside your computer, read the safety information that shipped with your computer and follow the steps in [Before working inside your computer](#). After working inside your computer, follow the instructions in [After working inside your computer](#). For more safety best practices, see the Regulatory Compliance home page at [www.dell.com/regulatory\\_compliance](http://www.dell.com/regulatory_compliance).

## Prerequisites

Remove the [base cover](#).

## Procedure

- 1 Locate the wireless card on your computer.

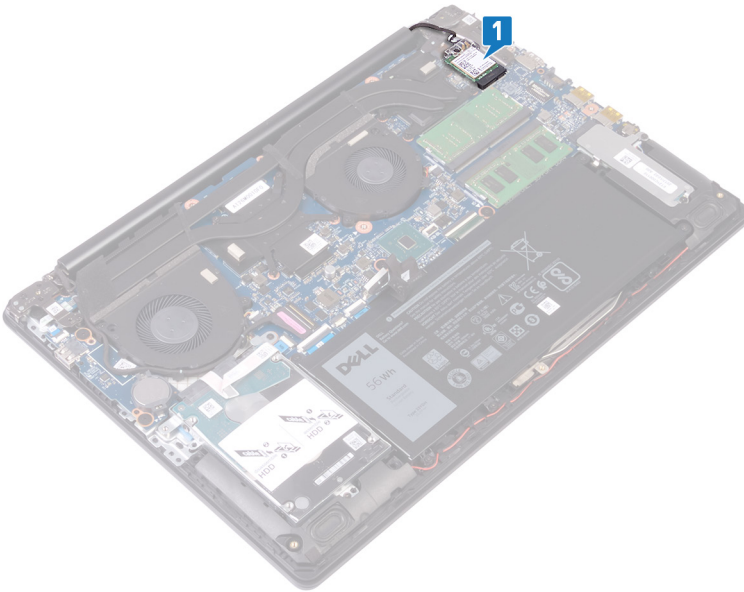

- 2 Remove the screw (M2x3) that secures the wireless-card bracket to the system board.
- 3 Slide and remove the wireless-card bracket from the wireless card.
- 4 Disconnect the antenna cables from the wireless card.
- 5 Slide and remove the wireless card from the wireless-card slot.

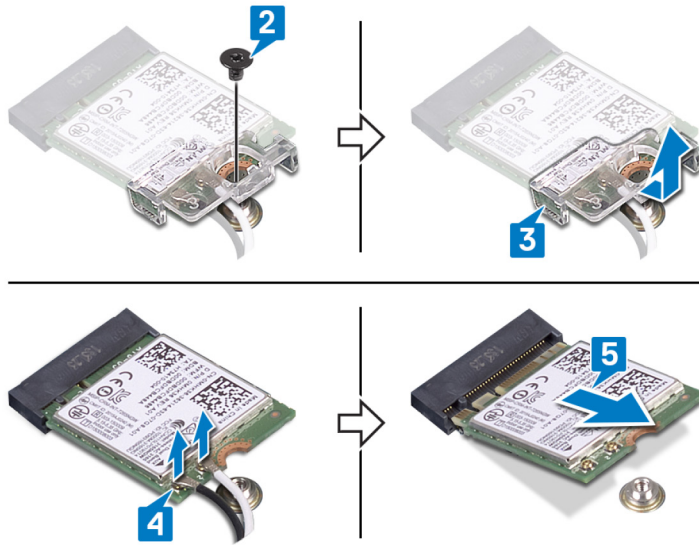

# Replacing the wireless card

**⚠ WARNING:** Before working inside your computer, read the safety information that shipped with your computer and follow the steps in [Before working inside your computer](#). After working inside your computer, follow the instructions in [After working inside your computer](#). For more safety best practices, see the Regulatory Compliance home page at [www.dell.com/regulatory\\_compliance](http://www.dell.com/regulatory_compliance).

## Procedure

**⚠ CAUTION:** To avoid damage to the wireless card, do not place any cables under it.

- 1 Connect the antenna cables to the wireless card.  
The following table provides the antenna-cable color scheme for the wireless card supported by your computer.

**Table 2. Antenna-cable color scheme**

Connectors on the wireless card	Antenna-cable color
Main (white triangle)	White
Auxiliary (black triangle)	Black

- 2 Slide and replace the wireless-card bracket on the wireless-card.
- 3 Align the notch on the wireless card with the tab on the wireless-card slot and insert the wireless card at an angle into the wireless-card slot.
- 4 Replace the screw (M2x3) that secures the wireless-card bracket to the wireless card and the palm rest and keyboard assembly.

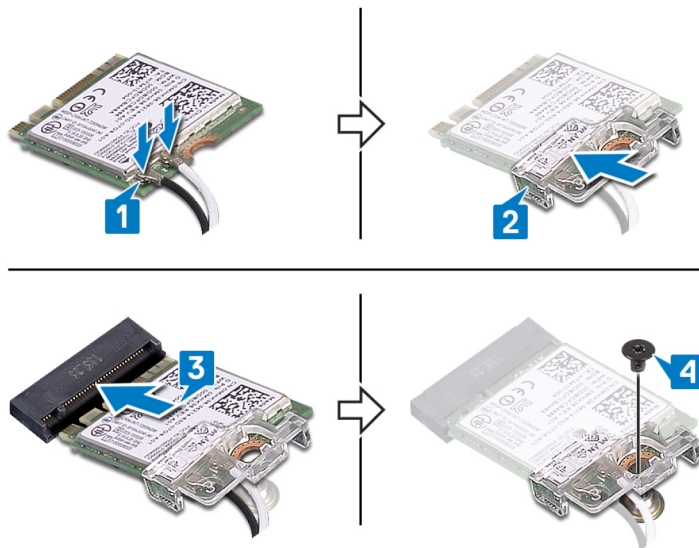

## Post-requisites

Replace the [base cover](#).

# Removing the coin-cell battery

- WARNING:** Before working inside your computer, read the safety information that shipped with your computer and follow the steps in [Before working inside your computer](#). After working inside your computer, follow the instructions in [After working inside your computer](#). For more safety best practices, see the Regulatory Compliance home page at [www.dell.com/regulatory\\_compliance](http://www.dell.com/regulatory_compliance).
- CAUTION:** Removing the coin-cell battery resets the BIOS setup program's settings to default. It is recommended that you note the BIOS setup program's settings before removing the coin-cell battery.

## Prerequisites

Remove the [base cover](#).

## Procedure

- CAUTION:** Removing the coin-cell battery resets the BIOS setup program's settings to default. Before removing the coin-cell battery, it is recommended to note the BIOS setup program's settings.

Using a plastic scribe, gently pry the coin-cell battery out of the battery socket on the I/O board.

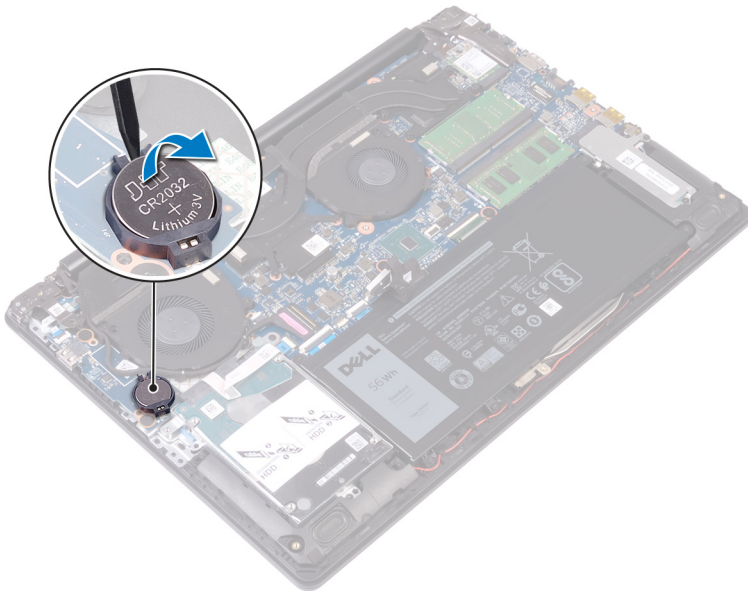

# Replacing the coin-cell battery

**⚠ WARNING:** Before working inside your computer, read the safety information that shipped with your computer and follow the steps in [Before working inside your computer](#). After working inside your computer, follow the instructions in [After working inside your computer](#). For more safety best practices, see the Regulatory Compliance home page at [www.dell.com/regulatory\\_compliance](http://www.dell.com/regulatory_compliance).

## Procedure

With the positive-side facing up, snap the coin-cell battery into the battery socket on the I/O board.

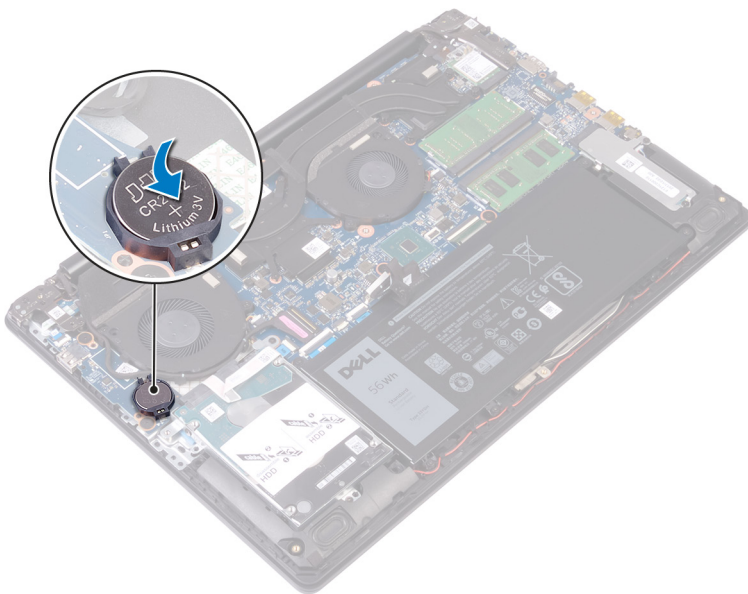

## Post-requisites

Replace the [base cover](#).



# Removing the fan

**⚠ WARNING:** Before working inside your computer, read the safety information that shipped with your computer and follow the steps in [Before working inside your computer](#). After working inside your computer, follow the instructions in [After working inside your computer](#). For more safety best practices, see the Regulatory Compliance home page at [www.dell.com/regulatory\\_compliance](http://www.dell.com/regulatory_compliance).

## Prerequisites

Remove the [base cover](#).

## Procedure

- 1 Open the latch and disconnect the display cable from the system board.
- 2 Remove the display cable from the routing guides on the fan.

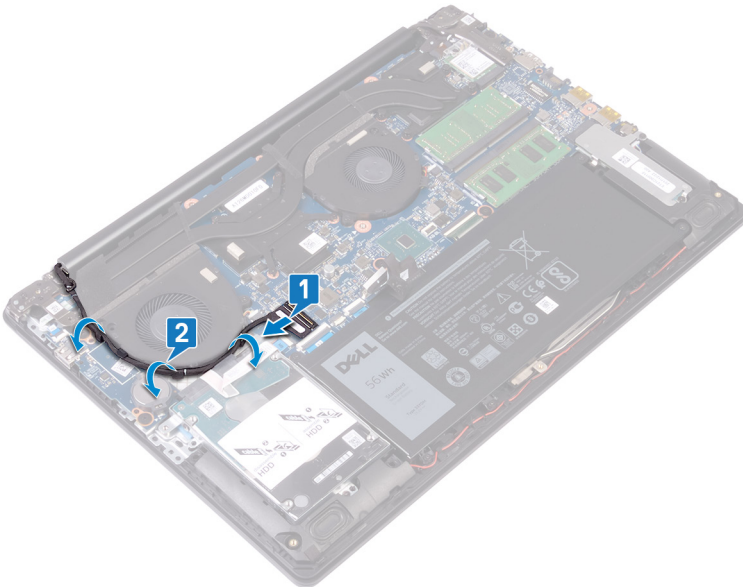

- 3 Disconnect the fan cable from the system board.
- 4 Remove the two screws (M2.5x6) that secure the fan to the palm rest and keyboard assembly.
- 5 Lift the fan off the palm rest and keyboard assembly.



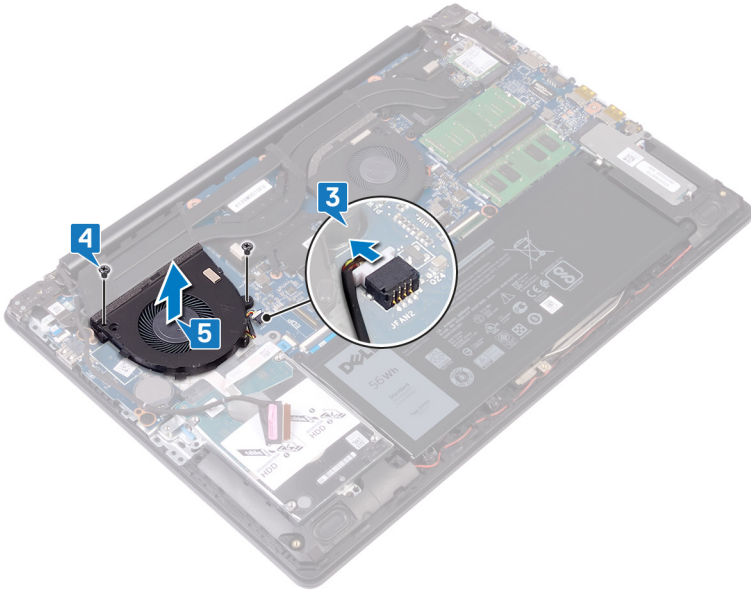

# Replacing the fan

**⚠ WARNING:** Before working inside your computer, read the safety information that shipped with your computer and follow the steps in [Before working inside your computer](#). After working inside your computer, follow the instructions in [After working inside your computer](#). For more safety best practices, see the Regulatory Compliance home page at [www.dell.com/regulatory\\_compliance](http://www.dell.com/regulatory_compliance).

## Procedure

- 1 Align the screw holes on the fan with the screw holes on to the palm rest and keyboard assembly.
- 2 Replace the two screws (M2.5x6) that secure the fan to the palm rest and keyboard assembly.
- 3 Connect the fan cable to the system board.

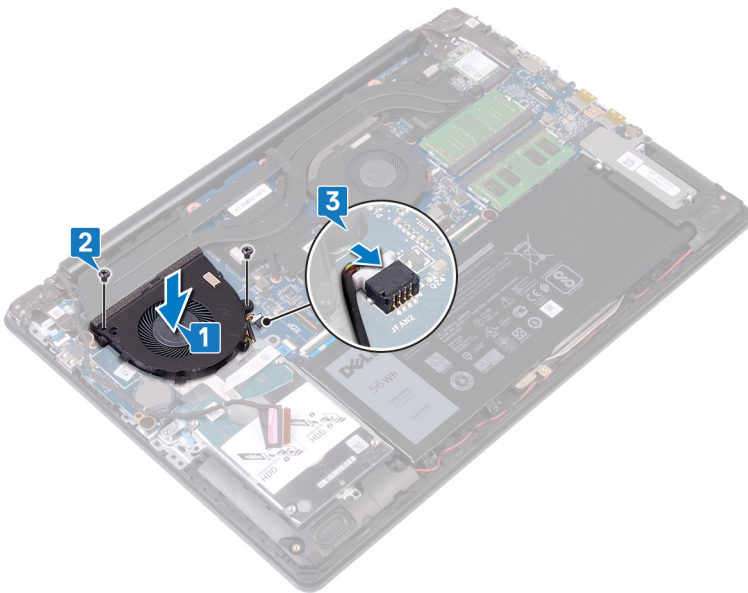

- 4 Route the display cable through the routing guides on the fan.
- 5 Connect the display cable to its connector on the system board and close the latch.

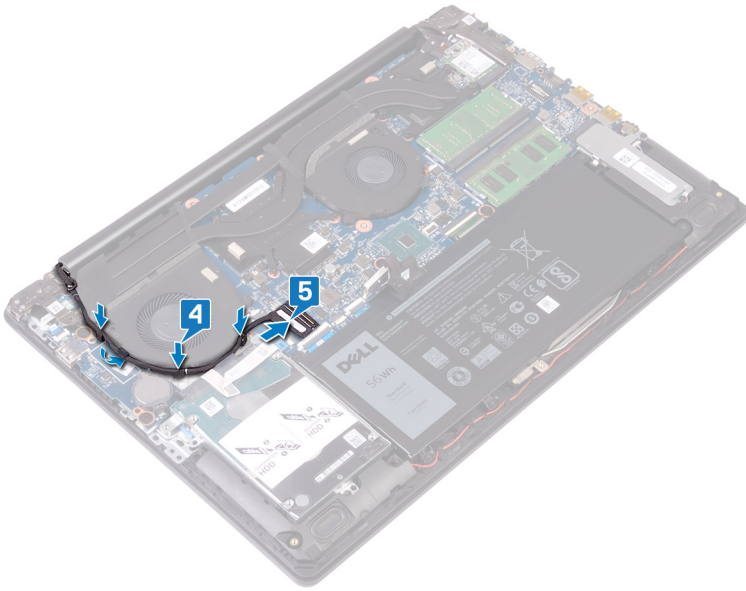

## Post-requisites

Replace the [base cover](#).

# Removing the processor fan

**⚠ WARNING:** Before working inside your computer, read the safety information that shipped with your computer and follow the steps in [Before working inside your computer](#). After working inside your computer, follow the instructions in [After working inside your computer](#). For more safety best practices, see the Regulatory Compliance home page at [www.dell.com/regulatory\\_compliance](http://www.dell.com/regulatory_compliance).

## Prerequisites

Remove the [base cover](#).

## Procedure

- 1 Disconnect the processor-fan cable from the system board.
- 2 Remove the two screws (M2.5x6) that secure the processor fan to the palm rest and keyboard assembly.
- 3 Lift the processor fan from the heat-sink.

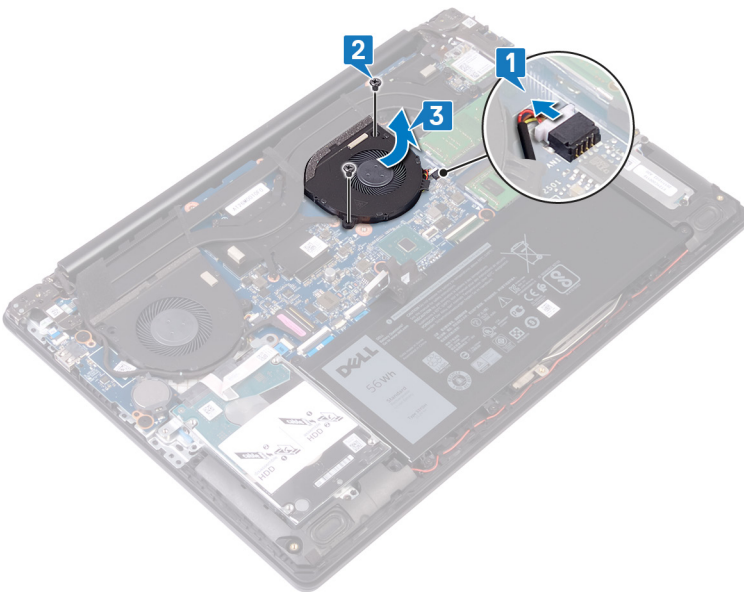

# Replacing the processor fan

**⚠ WARNING:** Before working inside your computer, read the safety information that shipped with your computer and follow the steps in [Before working inside your computer](#). After working inside your computer, follow the instructions in [After working inside your computer](#). For more safety best practices, see the Regulatory Compliance home page at [www.dell.com/regulatory\\_compliance](http://www.dell.com/regulatory_compliance).

## Procedure

- 1 Align the screw holes on the processor fan with the screw holes on the palm rest and keyboard assembly.
- 2 Replace the two screws (M2.5x6) that secure the processor fan to the palm rest and keyboard assembly.
- 3 Slide and connect the processor-fan cable into the connector on the system board.

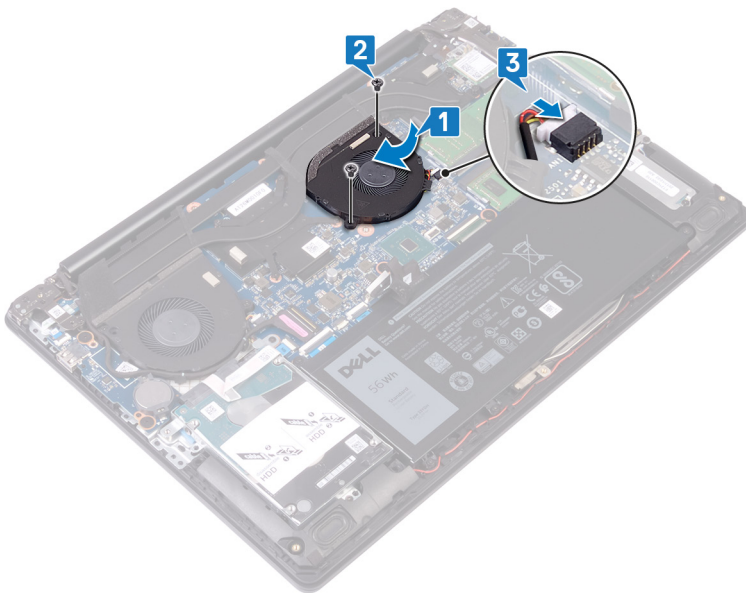

## Post-requisites

Replace the [base cover](#).

# Removing the solid-state drive/Intel Optane

You need to disable the Intel Optane before removing it from your computer. For more information about disabling the Intel Optane, see [Disabling Intel Optane](#).

**⚠ WARNING:** Before working inside your computer, read the safety information that shipped with your computer and follow the steps in [Before working inside your computer](#). After working inside your computer, follow the instructions in [After working inside your computer](#). For more safety best practices, see the Regulatory Compliance home page at [www.dell.com/regulatory\\_compliance](http://www.dell.com/regulatory_compliance).

## Prerequisites

Remove the [base cover](#).

## Procedure

- 1 Loosen the captive screw that secures the solid-state drive shield/Intel Optane shield and solid-state drive/Intel Optane to the palm rest and keyboard assembly.

**ⓘ NOTE:** Solid-state drive shield is available only on computers shipped with NVMe solid-state drive.

- 2 In computers shipped with mSATA solid-state drive/Intel Optane, remove the screw (M2x3) that secures the solid-state drive/Intel Optane to the palm rest and keyboard assembly.
- 3 Slide the solid-state drive shield/Intel Optane shield and lift the solid-state drive shield/Intel Optane shield off the palm rest and keyboard assembly.
- 4 Slide and remove the solid-state drive/Intel Optane from the slot.

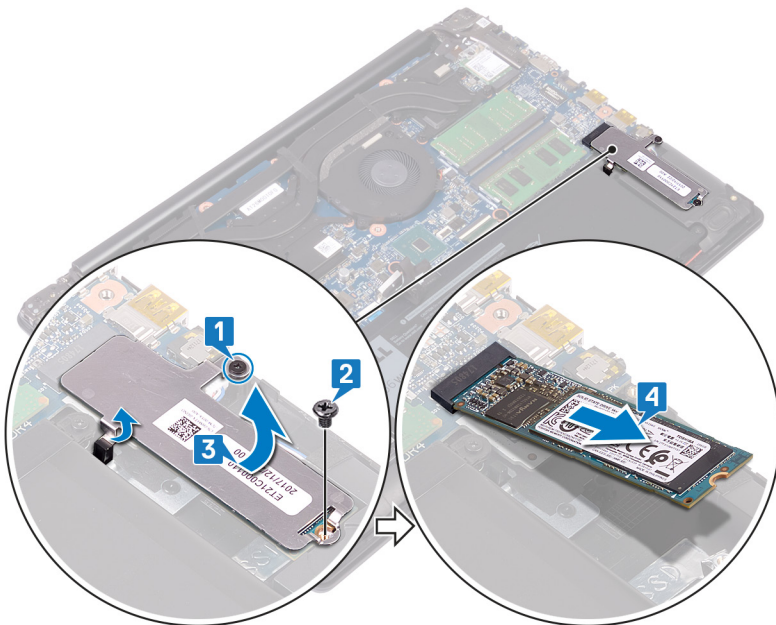

# Replacing the solid-state drive/Intel Optane

Enable the Intel Optane after you replace it. For more information about enabling the Intel Optane, see [Enabling Intel Optane](#).

**⚠ WARNING:** Before working inside your computer, read the safety information that shipped with your computer and follow the steps in [Before working inside your computer](#). After working inside your computer, follow the instructions in [After working inside your computer](#). For more safety best practices, see the Regulatory Compliance home page at [www.dell.com/regulatory\\_compliance](http://www.dell.com/regulatory_compliance).

**⚠ CAUTION:** Solid-state drives are fragile. Exercise care when handling the solid-state drive.

## Procedure

- 1 Align the notch on the solid-state drive/Intel Optane with the tab on the slot and slide the solid-state drive/Intel Optane into the slot.

**ⓘ NOTE:** Solid-state drive shield is available only on computers shipped with NVMe solid-state drive.

- 2 Slide the solid-state drive shield/Intel Optane shield into the tabs and replace the solid-state drive shield/Intel Optane shield on the palm rest and keyboard assembly.
- 3 Replace the screw (M2x3) that secures the solid-state drive/Intel Optane to the palm rest and keyboard assembly.
- 4 Tighten the captive screw that secures the solid-state drive shield/Intel Optane shield and solid-state drive/Intel Optane to the palm rest and keyboard assembly.

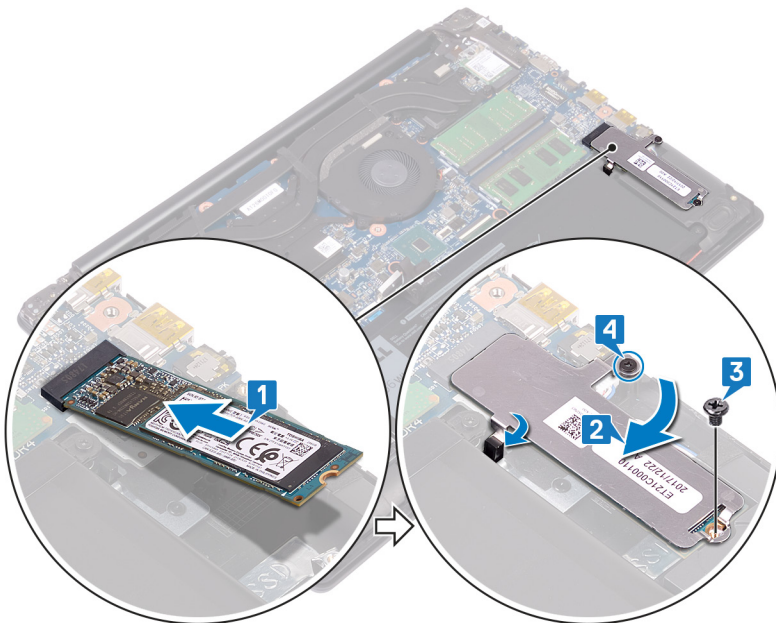

## Post-requisites

Replace the [base cover](#).



# Removing the hard drive

If your computer is using a SATA storage device accelerated by Intel Optane memory, disable Intel Optane before removing the SATA storage device. For more information about disabling the Intel Optane, see [Disabling Intel Optane](#).

**⚠ WARNING:** Before working inside your computer, read the safety information that shipped with your computer and follow the steps in [Before working inside your computer](#). After working inside your computer, follow the instructions in [After working inside your computer](#). For more safety best practices, see the Regulatory Compliance home page at [www.dell.com/regulatory\\_compliance](http://www.dell.com/regulatory_compliance).

**⚠ CAUTION:** Hard drives are fragile. Exercise care when handling the hard drive.

**⚠ CAUTION:** To avoid data loss, do not remove the hard drive while the computer is in sleep or on state.

## Prerequisites

- 1 Remove the [base cover](#).
- 2 Remove the [battery](#).

## Procedure

- 1 Open the latch and using the pull tab, disconnect the hard-drive cable from the system board.
- 2 Remove the two screws (M2x3) that secure the hard-drive assembly to the palm rest and keyboard assembly.
- 3 Lift the hard-drive assembly along with its cable off the palm rest and keyboard assembly.

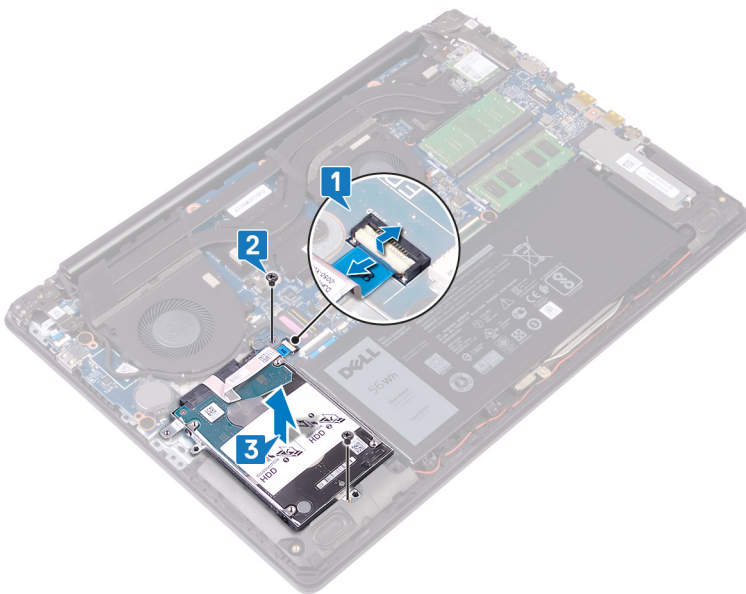

- 4 Disconnect the interposer from the hard-drive assembly.



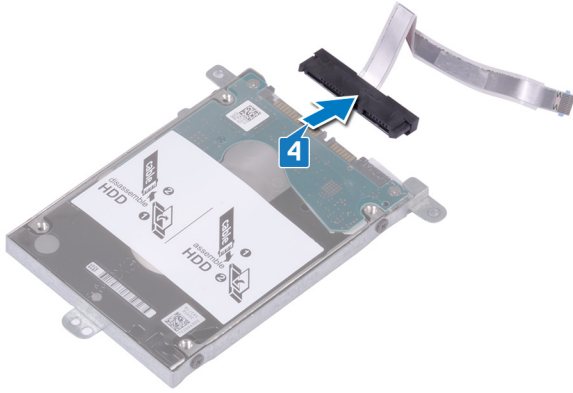

- 5 Remove the four screws (M3x3) that secure the hard-drive bracket to the hard drive.
- 6 Lift the hard drive off the hard-drive bracket.

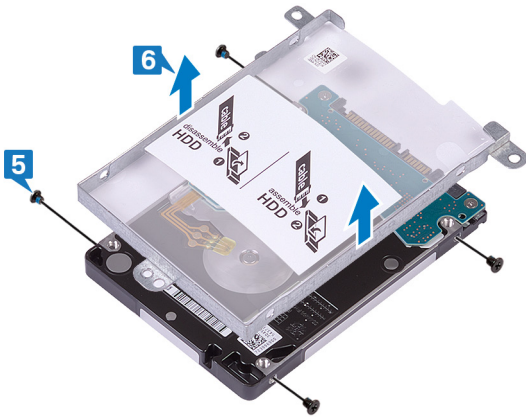

# Replacing the hard drive

Enable Intel Optane after replacing the SATA storage. For more information about enabling the Intel Optane, see [Enabling Intel Optane](#).

**⚠ WARNING:** Before working inside your computer, read the safety information that shipped with your computer and follow the steps in [Before working inside your computer](#). After working inside your computer, follow the instructions in [After working inside your computer](#). For more safety best practices, see the Regulatory Compliance home page at [www.dell.com/regulatory\\_compliance](http://www.dell.com/regulatory_compliance).

**⚠ CAUTION:** Hard drives are fragile. Exercise care when handling the hard drive.

## Procedure

- 1 Place the hard-drive bracket on the hard drive and align the screw holes on the hard-drive bracket with the screw holes on the hard drive.
- 2 Replace the four screws (M3x3) that secure the hard-drive bracket to the hard drive.

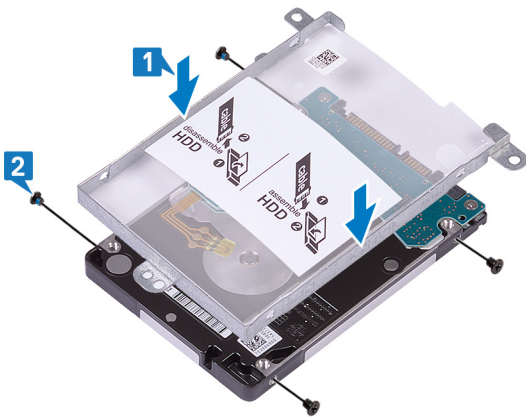

- 3 Connect the interposer to the hard-drive assembly.

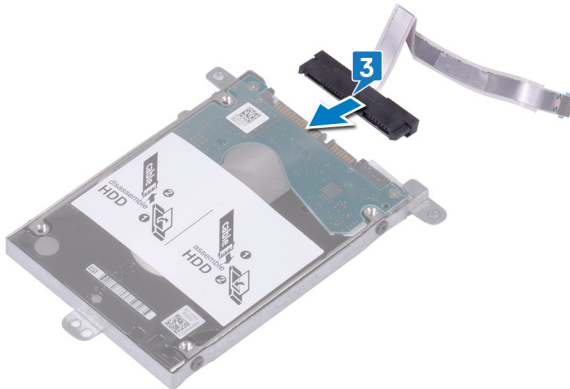

- 4 Align the screw holes on the hard-drive assembly with the screw holes on the palm rest and keyboard assembly.
- 5 Replace the two screws (M2x3) that secure the hard-drive assembly to the palm rest and keyboard assembly.
- 6 Fold the hard-drive cable and connect it to the system board.
- 7 Slide the hard-drive cable into the connector on the system board and close the latch.

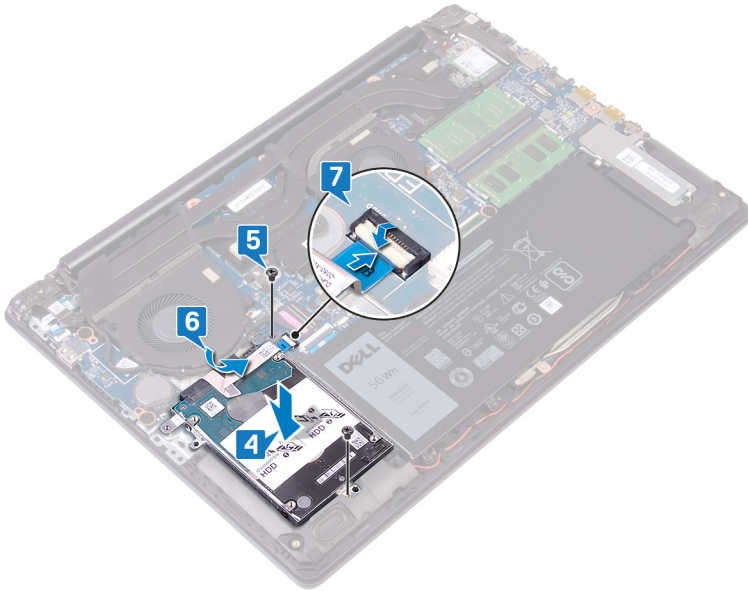

## Post-requisites

- 1 Replace the [battery](#).
- 2 Replace the [base cover](#).

# Removing the touchpad

**⚠ WARNING:** Before working inside your computer, read the safety information that shipped with your computer and follow the steps in [Before working inside your computer](#). After working inside your computer, follow the instructions in [After working inside your computer](#). For more safety best practices, see the Regulatory Compliance home page at [www.dell.com/regulatory\\_compliance](http://www.dell.com/regulatory_compliance).

## Prerequisites

- 1 Remove the [base cover](#).
- 2 Remove the [battery](#).

## Procedure

- 1 Open the latch and disconnect the touchpad cable from the system board.
- 2 Gently peel the tape that secures the touchpad to the palm rest and keyboard assembly.
- 3 Remove the four screws (M2x2) that secure the touchpad to the palm rest and keyboard assembly.
- 4 Slide the touchpad along with its cable at an angle and lift the touchpad off the palm rest and keyboard assembly.

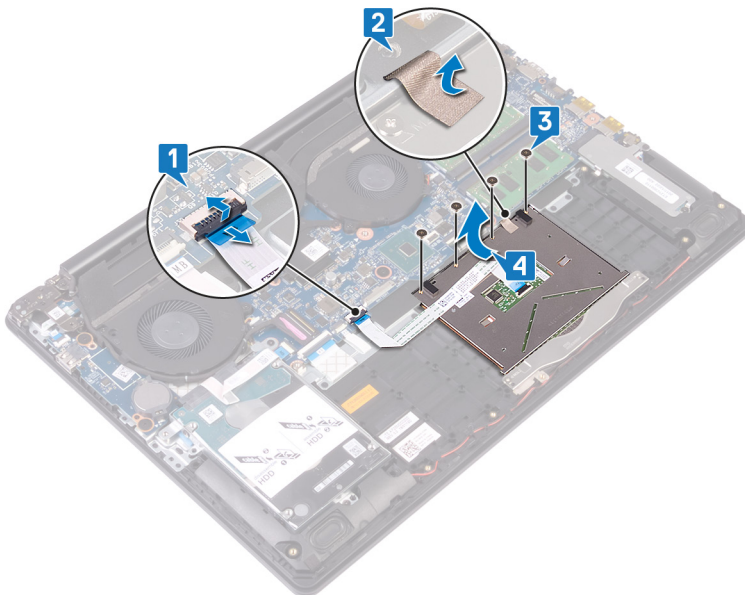

# Replacing the touchpad

**⚠ WARNING:** Before working inside your computer, read the safety information that shipped with your computer and follow the steps in [Before working inside your computer](#). After working inside your computer, follow the instructions in [After working inside your computer](#). For more safety best practices, see the Regulatory Compliance home page at [www.dell.com/regulatory\\_compliance](http://www.dell.com/regulatory_compliance).

## Procedure

**① NOTE:** Ensure that the touchpad is aligned with the guides available on the palm-rest and keyboard assembly, and the gap on either sides of the touchpad is equal.

- 1 Slide and place the touchpad into the slot on the palm rest and keyboard assembly.
- 2 Replace the four screws (M2x2) that secure the touchpad to the palm rest and keyboard assembly.
- 3 Adhere the tape that secures the touchpad to the palm rest and keyboard assembly.
- 4 Slide the touchpad cable into the connector on the system board and close the latch.

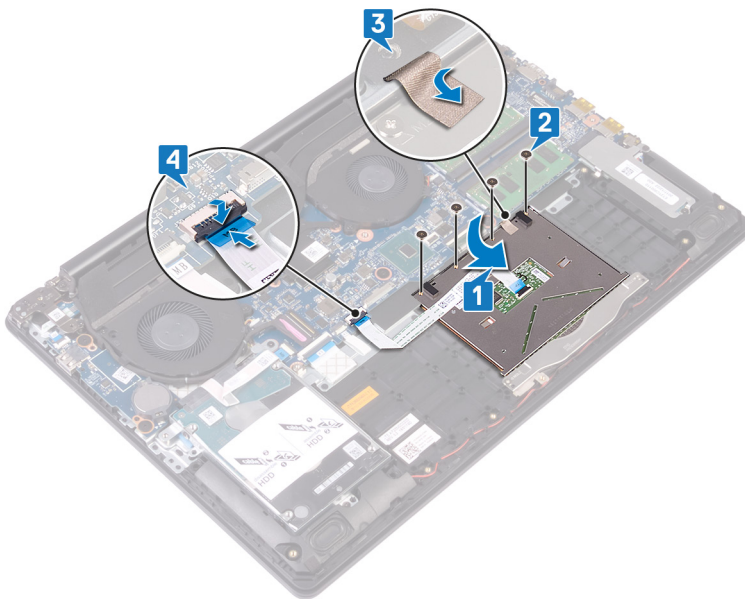

## Post-requisites

- 1 Replace the [battery](#).
- 2 Replace the [base cover](#).

# Removing the power-adapter port

**⚠ WARNING:** Before working inside your computer, read the safety information that shipped with your computer and follow the steps in [Before working inside your computer](#). After working inside your computer, follow the instructions in [After working inside your computer](#). For more safety best practices, see the Regulatory Compliance home page at [www.dell.com/regulatory\\_compliance](http://www.dell.com/regulatory_compliance).

## Prerequisites

- 1 Remove the [base cover](#).
- 2 Remove the [wireless card](#).

## Procedure

**Applicable on computers that are shipped with power button only.**

- 1 Remove the three screws (M2.5x6) that secure the right hinge to the system board and palm rest assembly.
- 2 Lift the right hinge.
- 3 Disconnect the power-adapter port cable from the system board.
- 4 Peel and lift the power-adapter port along with its cable off the palm rest and keyboard assembly.

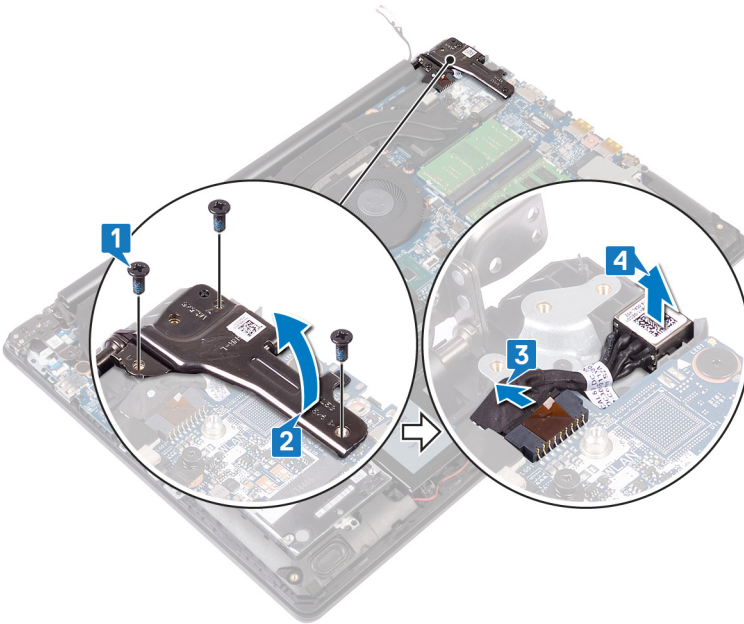

# Replacing the power-adapter port

**⚠ WARNING:** Before working inside your computer, read the safety information that shipped with your computer and follow the steps in [Before working inside your computer](#). After working inside your computer, follow the instructions in [After working inside your computer](#). For more safety best practices, see the Regulatory Compliance home page at [www.dell.com/regulatory\\_compliance](http://www.dell.com/regulatory_compliance).

## Procedure

- 1 Place the power-adapter port into the slot and adhere the power-adapter port on the palm rest and keyboard assembly.
- 2 Connect the power-adapter port cable to the system board.
- 3 Close the right hinge.
- 4 Replace the three screws (M2.5x6) that secure the right hinge to the system board and palm rest assembly.

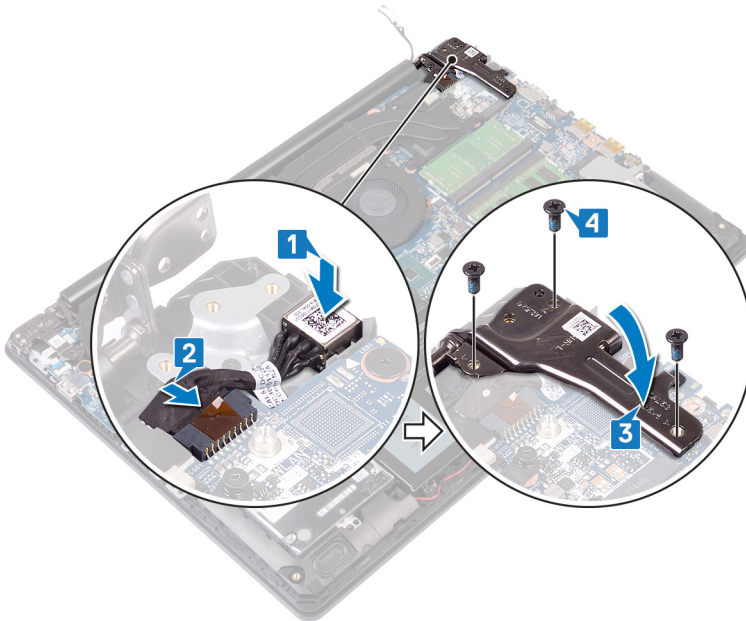

## Post-requisites

- 1 Replace the [wireless card](#).
- 2 Replace the [base cover](#).



# Removing the speakers

**⚠ WARNING:** Before working inside your computer, read the safety information that shipped with your computer and follow the steps in [Before working inside your computer](#). After working inside your computer, follow the instructions in [After working inside your computer](#). For more safety best practices, see the Regulatory Compliance home page at [www.dell.com/regulatory\\_compliance](http://www.dell.com/regulatory_compliance).

## Prerequisites

Remove the [base cover](#).

## Procedure

- 1 Disconnect the speaker cable from the system board and lift the right speaker off the palm rest and keyboard assembly.
- 2 Note the speaker cable routing and remove it from the routing guides on palm rest and key board assembly.
- 3 Lift the left speaker, along with the cable, off the palm rest and keyboard assembly.

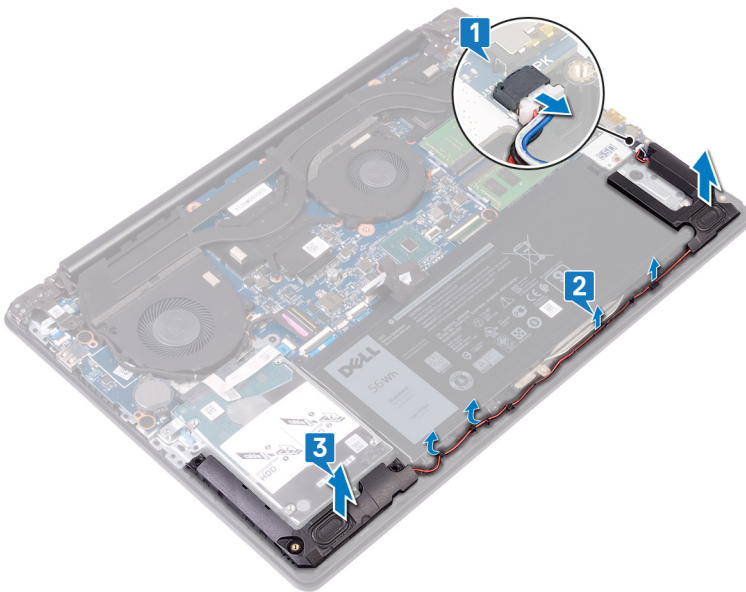



# Replacing the speakers

**⚠ WARNING:** Before working inside your computer, read the safety information that shipped with your computer and follow the steps in [Before working inside your computer](#). After working inside your computer, follow the instructions in [After working inside your computer](#). For more safety best practices, see the Regulatory Compliance home page at [www.dell.com/regulatory\\_compliance](http://www.dell.com/regulatory_compliance).

## Procedure

**① NOTE:** If the rubber grommets are pushed out of the speakers when removing the speakers, push them back in place before replacing the speakers.

- 1 Using the alignment posts and rubber grommets, place the left speaker in the slots on the palm rest and keyboard assembly.
- 2 Route the speaker cable through the routing guides on the palm rest and keyboard assembly.
- 3 Replace the right speaker.
- 4 Connect the speaker cable to the system board.

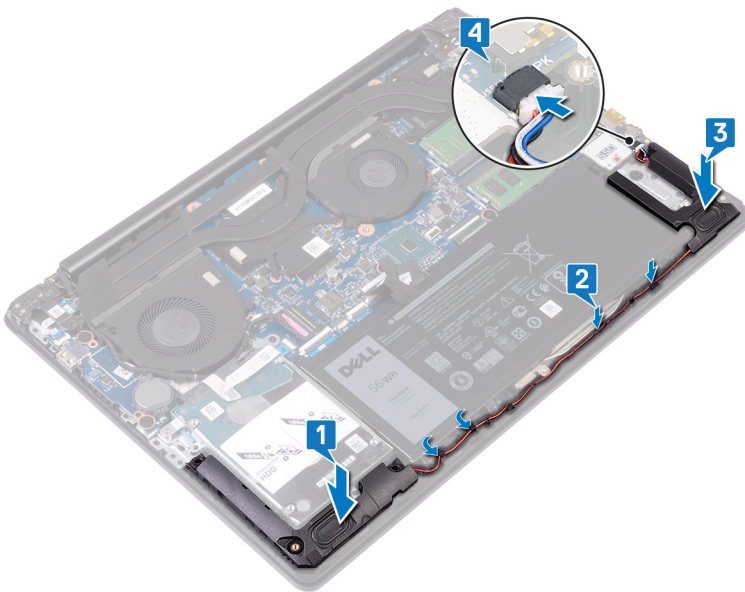

## Post-requisites

Replace the [base cover](#).

# Removing the heat sink

- ⚠ WARNING:** Before working inside your computer, read the safety information that shipped with your computer and follow the steps in [Before working inside your computer](#). After working inside your computer, follow the instructions in [After working inside your computer](#). For more safety best practices, see the Regulatory Compliance home page at [www.dell.com/regulatory\\_compliance](http://www.dell.com/regulatory_compliance).
- ⚠ WARNING:** The heat sink may become hot during normal operation. Allow sufficient time for the heat sink to cool before you touch it.
- ⚠ CAUTION:** For maximum cooling of the processor, do not touch the heat transfer areas on the heat sink. The oils in your skin can reduce the heat transfer capability of the thermal grease.

## Prerequisites

Remove the [base cover](#).

## Procedure

- 1 Remove the four (M2x3) screws in the reverse sequential order (8>7>6>5) that secure the heat sink to the system board.
- 2 In the reverse sequential order (4>3>2>1), loosen the four captive screws that secure the heat sink to the system board.
- 3 Lift the heat sink off the system board.

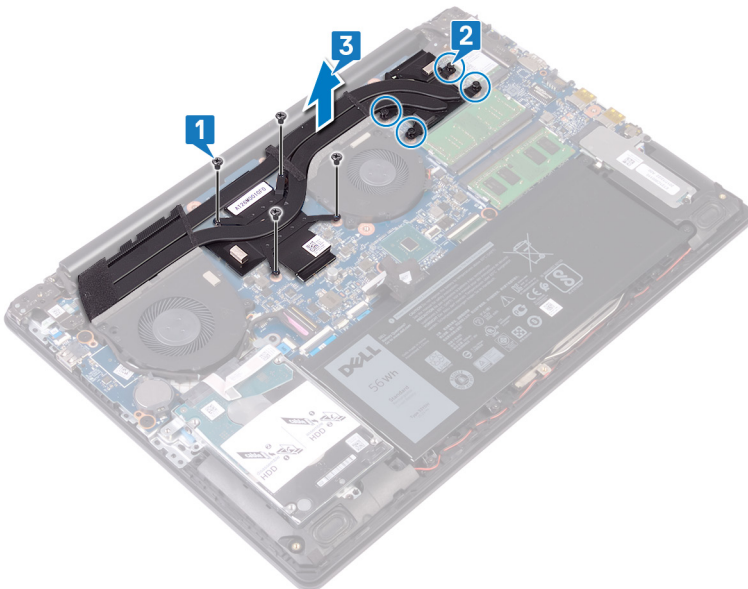

# Replacing the heat sink

**⚠ WARNING:** Before working inside your computer, read the safety information that shipped with your computer and follow the steps in [Before working inside your computer](#). After working inside your computer, follow the instructions in [After working inside your computer](#). For more safety best practices, see the Regulatory Compliance home page at [www.dell.com/regulatory\\_compliance](http://www.dell.com/regulatory_compliance).

**⚠ CAUTION:** Incorrect alignment of the heat sink can damage the system board and processor.

**ⓘ NOTE:** If either the system board or the heat sink is replaced, use the thermal pad provided in the kit to ensure that thermal conductivity is achieved.

## Procedure

- 1 Place the heat sink on the system board and align the screw holes on the heat sink with the screw holes on the system board.
- 2 Tighten the captive screws in the sequential order (1>2>3>4) to secure the heat sink to the system board.
- 3 Replace the four (M2x3) screws in the sequential order (5>6>7>8) that secure the heat sink to the system board.

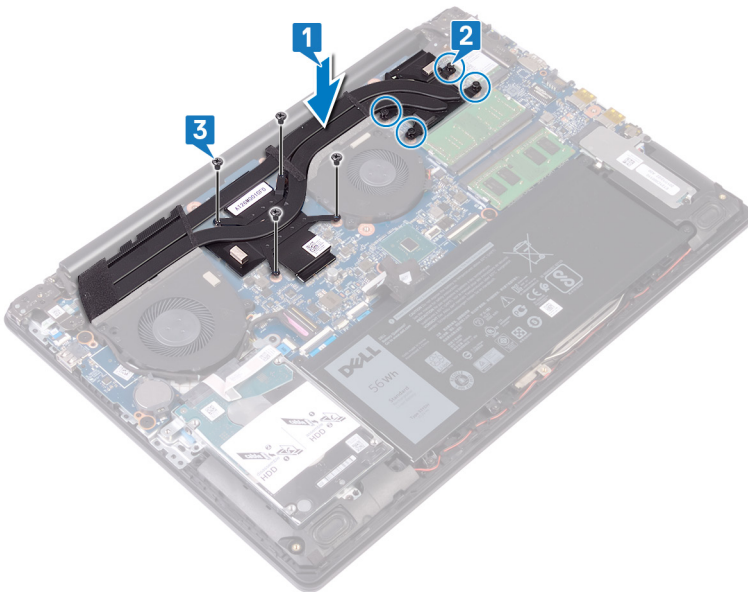

## Post-requisites

Replace the [base cover](#).

# Removing the display assembly

**⚠ WARNING:** Before working inside your computer, read the safety information that shipped with your computer and follow the steps in [Before working inside your computer](#). After working inside your computer, follow the instructions in [After working inside your computer](#). For more safety best practices, see the Regulatory Compliance home page at [www.dell.com/regulatory\\_compliance](http://www.dell.com/regulatory_compliance).

## Prerequisites

- 1 Remove the [base cover](#).
- 2 Remove the [wireless card](#).

## Procedure

- 1 Open the latch and disconnect the display cable from the system board.
- 2 Note the routing of the display cable and remove the cable from its routing guides on the fan and palm rest and keyboard assembly.
- 3 Remove the six screws (M2.5x6) that secure the left and right hinges to the system board and palm rest and keyboard assembly.

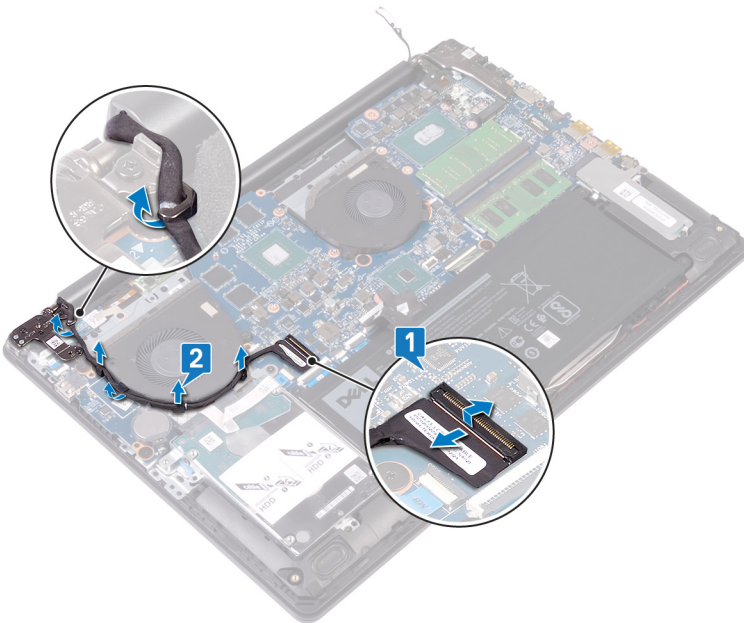

- 4 Open the hinges.

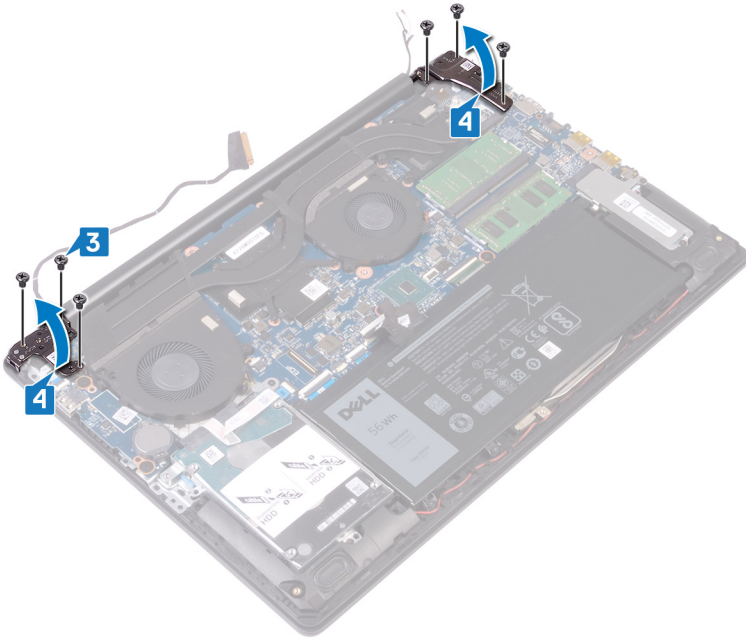

- 5 Lift the palm rest and keyboard assembly at an angle.
- 6 Slide and remove the palm rest and keyboard assembly off the display assembly.

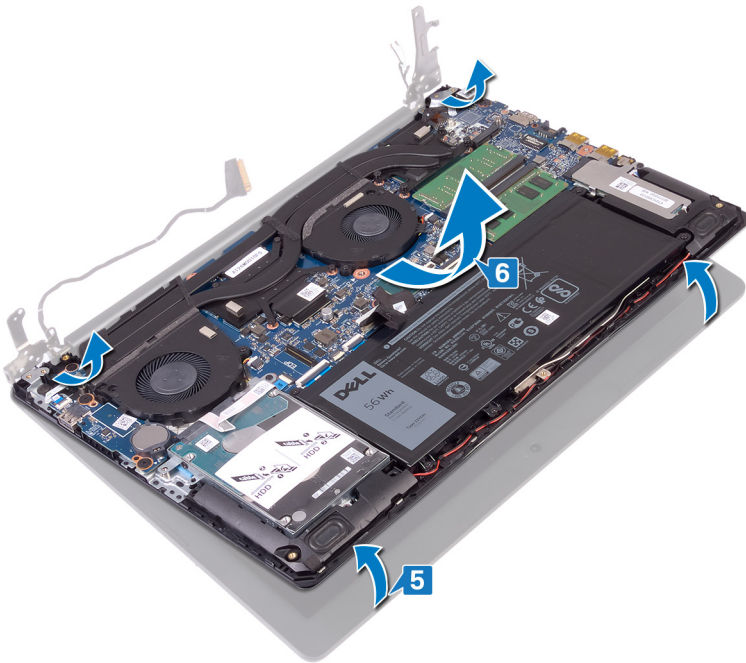

- 7 After performing all these steps, you are left with the display assembly.





# Replacing the display assembly

**⚠ WARNING:** Before working inside your computer, read the safety information that shipped with your computer and follow the steps in [Before working inside your computer](#). After working inside your computer, follow the instructions in [After working inside your computer](#). For more safety best practices, see the Regulatory Compliance home page at [www.dell.com/regulatory\\_compliance](http://www.dell.com/regulatory_compliance).

## Procedure

**① NOTE:** Ensure that the hinges are opened to the maximum before replacing the display assembly on palm rest and keyboard assembly.

- 1 Slide the palm rest and keyboard assembly at an angle under the hinges on the display assembly.
- 2 Place the palm rest and keyboard assembly on the display assembly.

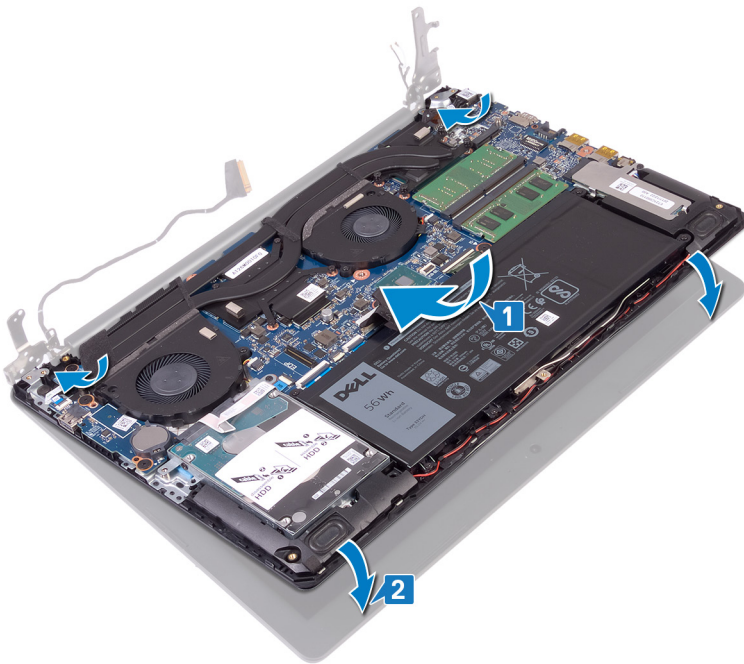

- 3 Using the alignment posts, press the hinges down on the system board and the palm rest and keyboard assembly.

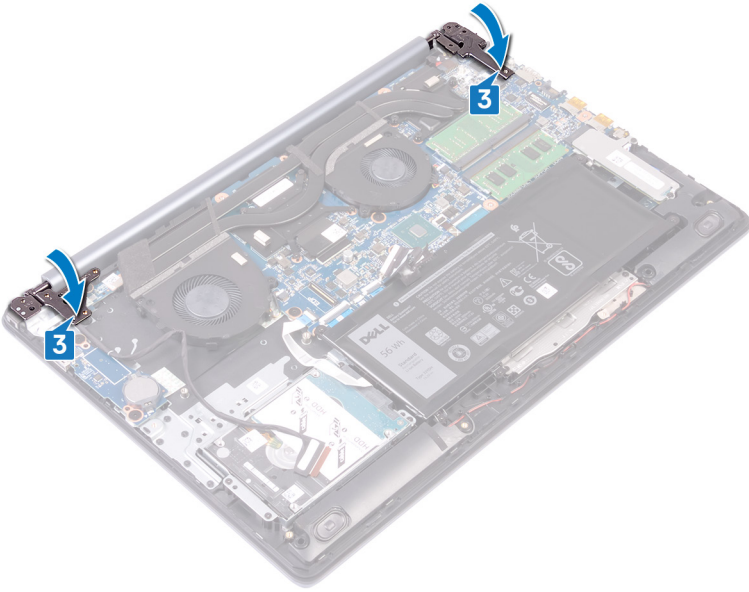

- 4 Replace the six screws (M2.5x6) that secure the left and right hinges to the system board and palm rest and keyboard assembly.

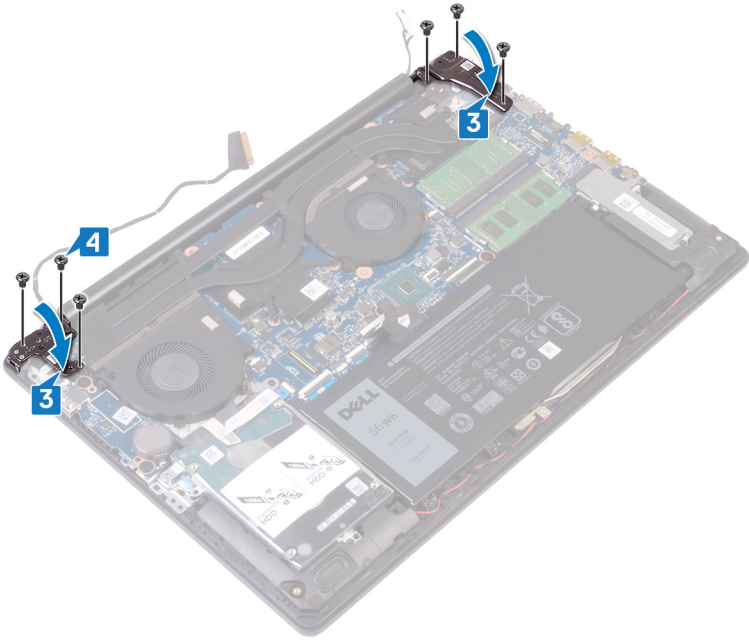

- 5 Route the display cable through the routing guides on the fan and the palm rest and keyboard assembly.
- 6 Slide the display cable into the connector on the system board and close the latch to secure the cable.



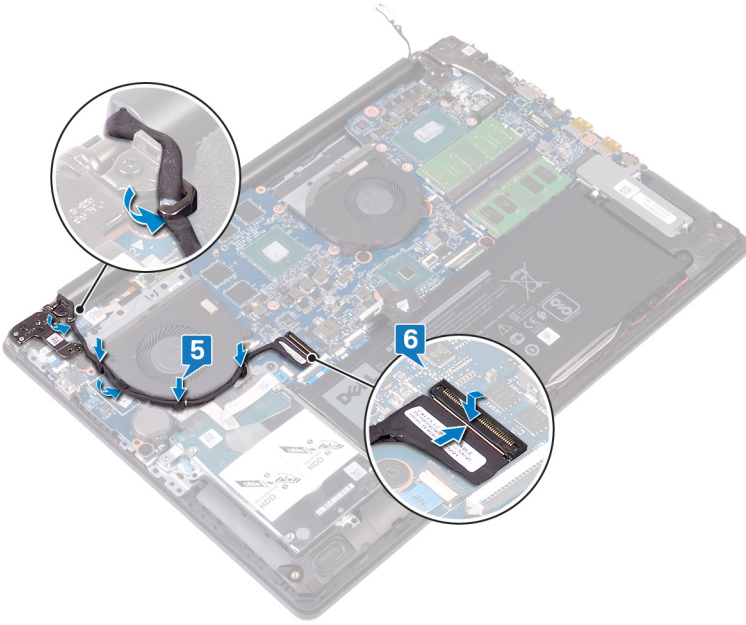

## Post-requisites

- 1 Replace the [wireless card](#).
- 2 Replace the [base cover](#).

# Removing the I/O board

**⚠ WARNING:** Before working inside your computer, read the safety information that shipped with your computer and follow the steps in [Before working inside your computer](#). After working inside your computer, follow the instructions in [After working inside your computer](#). For more safety best practices, see the Regulatory Compliance home page at [www.dell.com/regulatory\\_compliance](http://www.dell.com/regulatory_compliance).

## Prerequisites

**⚠ CAUTION:** Removing the coin-cell battery resets the BIOS setup program's settings to default. Before removing the I/O board along with the coin-cell battery, it is recommended to note the BIOS setup program's settings.

Remove the [base cover](#).

## Procedure

- 1 Open the latch and disconnect the power-button board cable from the system board.
- 2 Remove the two screws (M2.5x2.5) that secures the I/O board to the palm rest and keyboard assembly.
- 3 Turn the I/O-board over.
- 4 Open the latch and disconnect the I/O-board cable from the I/O-board.
- 5 Lift the I/O board off the palm rest and keyboard assembly.

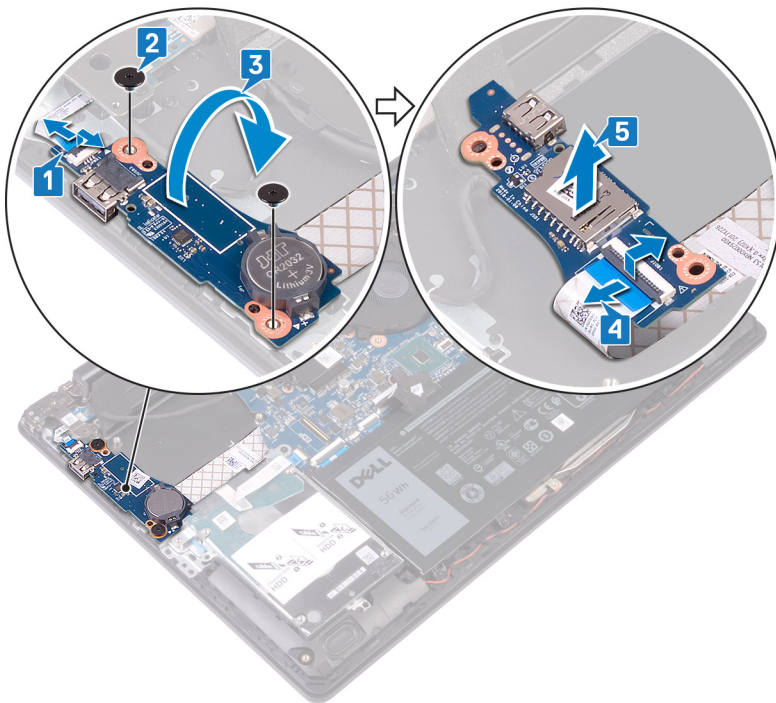

# Replacing the I/O board

**⚠ WARNING:** Before working inside your computer, read the safety information that shipped with your computer and follow the steps in [Before working inside your computer](#). After working inside your computer, follow the instructions in [After working inside your computer](#). For more safety best practices, see the Regulatory Compliance home page at [www.dell.com/regulatory\\_compliance](http://www.dell.com/regulatory_compliance).

## Procedure

- 1 Connect the I/O-board cable to the I/O board and close the latch.
- 2 Turn over the I/O board.
- 3 Using the alignment posts, place the I/O board on the palm rest and keyboard assembly.
- 4 Replace the two screws (M2.5x2.5) that secure the I/O board to the palm rest and keyboard assembly.
- 5 Connect the power-button board cable to the system board and close the latch.

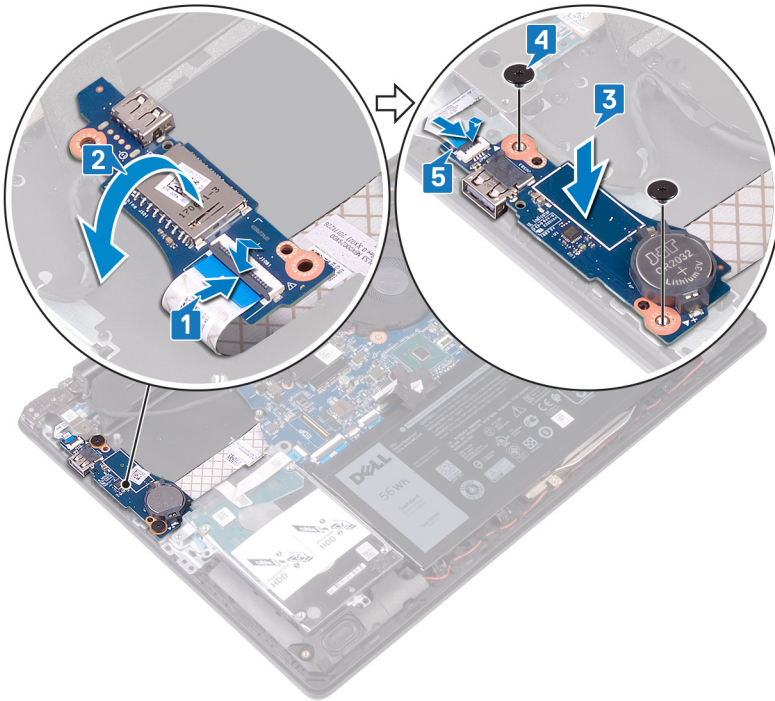

## Post-requisites

Replace the [base cover](#).

# Removing the power-button board

**⚠ WARNING:** Before working inside your computer, read the safety information that shipped with your computer and follow the steps in [Before working inside your computer](#). After working inside your computer, follow the instructions in [After working inside your computer](#). For more safety best practices, see the Regulatory Compliance home page at [www.dell.com/regulatory\\_compliance](http://www.dell.com/regulatory_compliance).

## Prerequisites

Remove the [base cover](#).

## Procedure

- 1 Open the latch and disconnect the display-assembly cable from the system board.
- 2 Note the routing of the display cable and remove the cable from its routing guides on the fan and palm rest and keyboard assembly.
- 3 Remove the three screws (M2.5x6) that secure the left hinge to palm rest and keyboard assembly.
- 4 Open the left hinge.

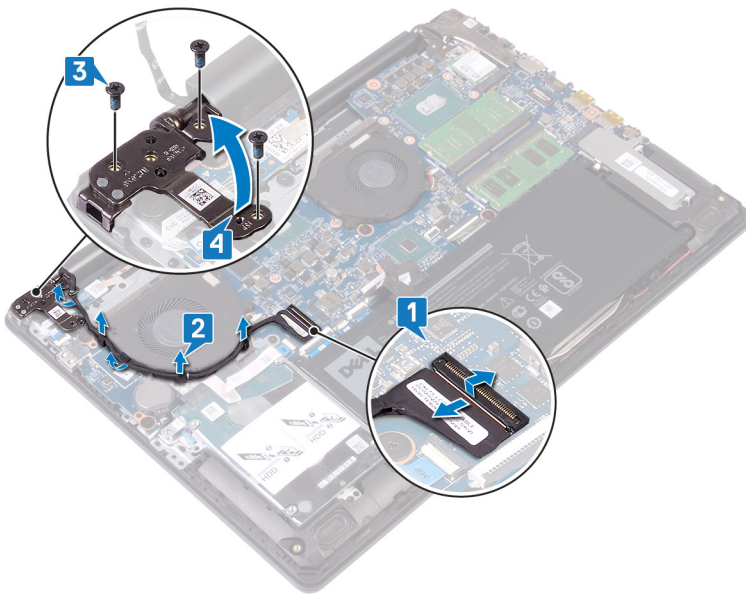

- 5 Open the latch and disconnect the power-button board cable from the I/O board.
- 6 Gently peel off the tape that secures the power-button board to the palm rest and keyboard assembly.
- 7 Remove the screw (M2x2) that secures the power-button board to the palm rest and keyboard assembly.
- 8 Release the power-button board from the tabs and lift the power-button board along with the cable off the palm rest and keyboard assembly.

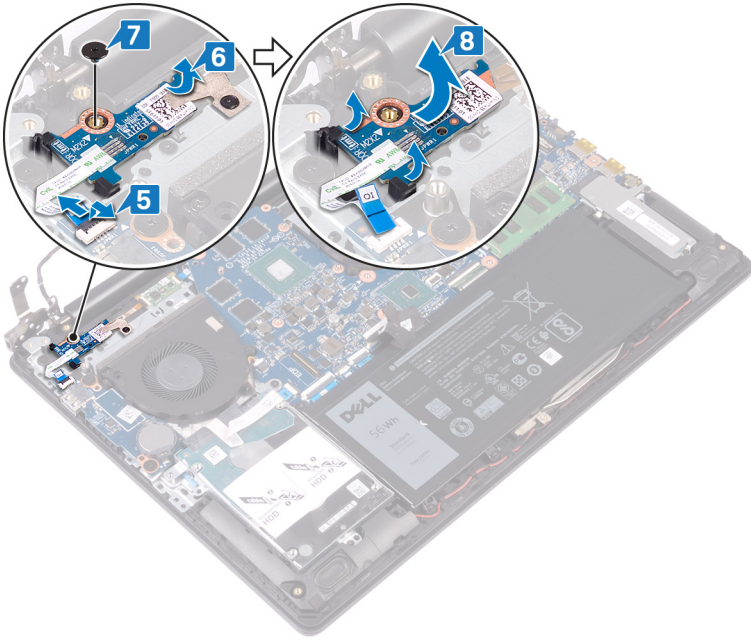

# Replacing the power-button board

**⚠ WARNING:** Before working inside your computer, read the safety information that shipped with your computer and follow the steps in [Before working inside your computer](#). After working inside your computer, follow the instructions in [After working inside your computer](#). For more safety best practices, see the Regulatory Compliance home page at [www.dell.com/regulatory\\_compliance](http://www.dell.com/regulatory_compliance).

## Procedure

- 1 Slide the power-button board into the tabs on the palm rest and keyboard assembly and then align the screw hole on the power-button board with the screw hole on the palm rest and keyboard assembly.
- 2 Replace the screw (M2x2) that secures the power-button board to the palm rest and keyboard assembly.
- 3 Adhere the tape that secures the power-button board to the palm rest and keyboard assembly.
- 4 Slide the power-button cable to the I/O board and close the latch.

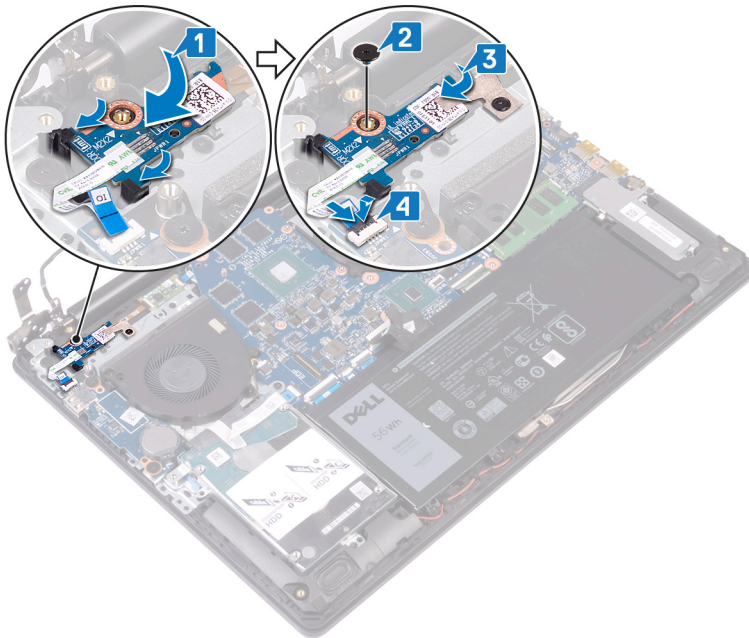

- 5 Close the left hinge.
- 6 Replace the three screws (M2.5x6) that secure the left hinge to palm rest and keyboard assembly.
- 7 Route the display cable through the routing guides on the fan and the palm rest and keyboard assembly.
- 8 Slide the display cable to the connector on the system board and close the latch.



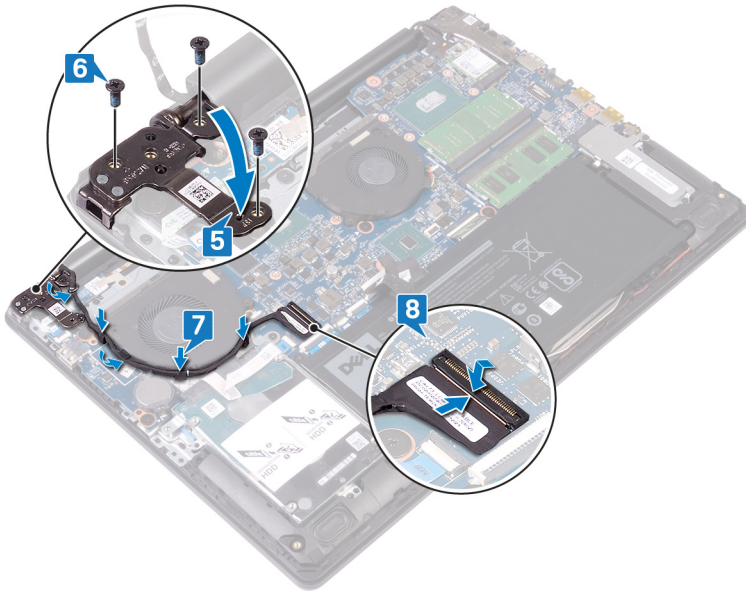

## Post-requisites

Replace the [base cover](#).

# Removing the system board

**⚠ WARNING:** Before working inside your computer, read the safety information that shipped with your computer and follow the steps in [Before working inside your computer](#). After working inside your computer, follow the instructions in [After working inside your computer](#). For more safety best practices, see the Regulatory Compliance home page at [www.dell.com/regulatory\\_compliance](http://www.dell.com/regulatory_compliance).

- ① **NOTE:** Your computer's Service Tag is stored in the system board. You must enter the Service Tag in the BIOS setup program after you replace the system board.
- ① **NOTE:** Replacing the system board removes any changes you have made to the BIOS using the BIOS setup program. You must make the appropriate changes again after you replace the system board.
- ① **NOTE:** Before disconnecting the cables from the system board, note the location of the connectors so that you can reconnect the cables correctly after you replace the system board.

## Prerequisites

- 1 Remove the [base cover](#).
- 2 Remove the [battery](#).
- 3 Remove the [memory modules](#).
- 4 Remove the [wireless card](#).
- 5 Remove the [solid-state drive/Intel Optane](#).
- 6 Remove the [heat sink](#).

## Procedure

- 1 Remove the three screws (M2.5x6) that secure the right hinge to the system board.
- 2 Open the right hinge.

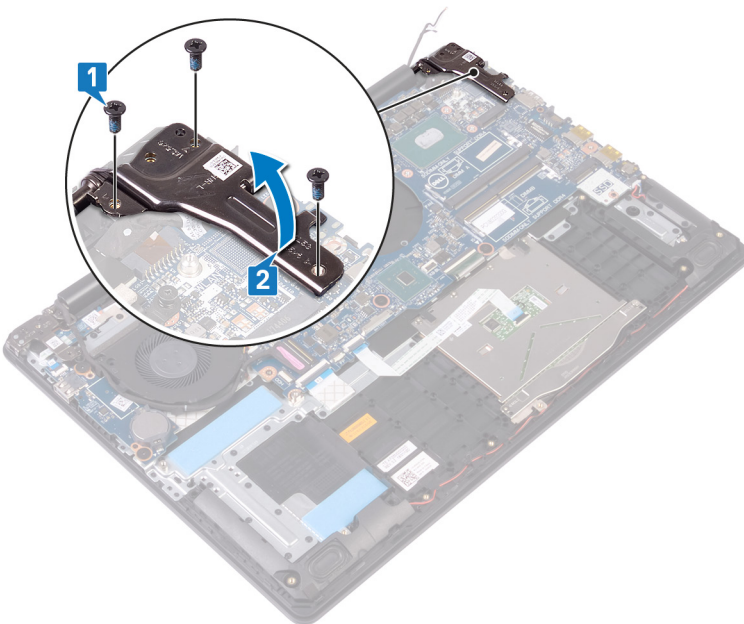



- 3 Disconnect the graphics-card fan cable.
- 4 Open the latch and disconnect the display-assembly cable.
- 5 Open the latch and disconnect the hard-drive cable.
- 6 Open the latch and disconnect the I/O-board cable.
- 7 Open the latch and disconnect the fingerprint-reader cable.
- 8 Open the latch and disconnect the touchpad cable.
- 9 Open the latch and disconnect the keyboard back-light cable.
- 10 Open the latch and disconnect the keyboard cable.
- 11 Disconnect the speaker cable.
- 12 Disconnect the power-adaptor port cable.

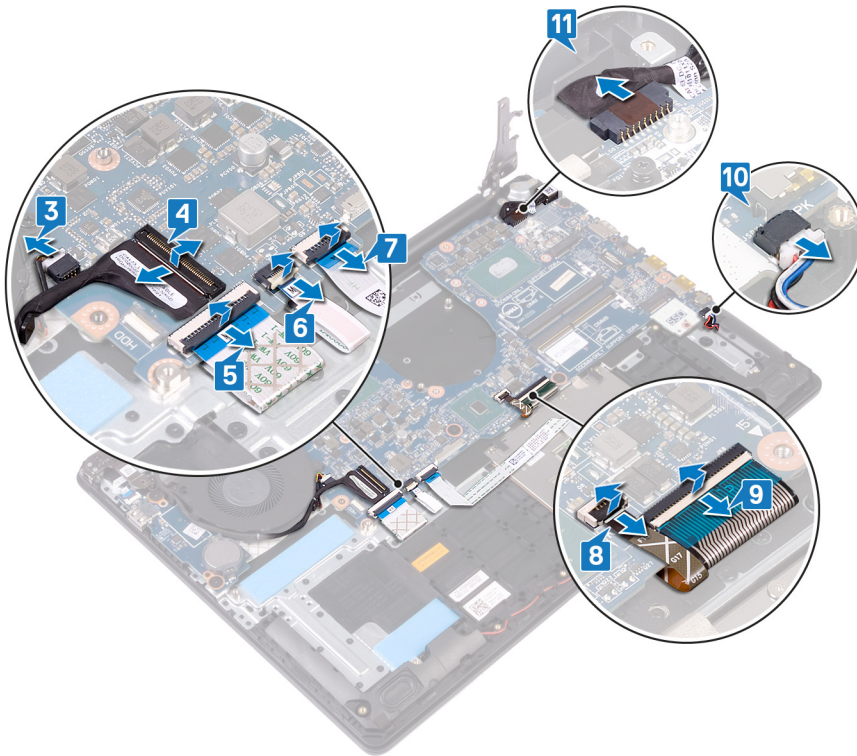

- 13 Remove the three screws (M2.5x2.5) that secure the system board to palm rest and keyboard assembly.
- 14 Lift the system board off the palm rest and keyboard assembly.

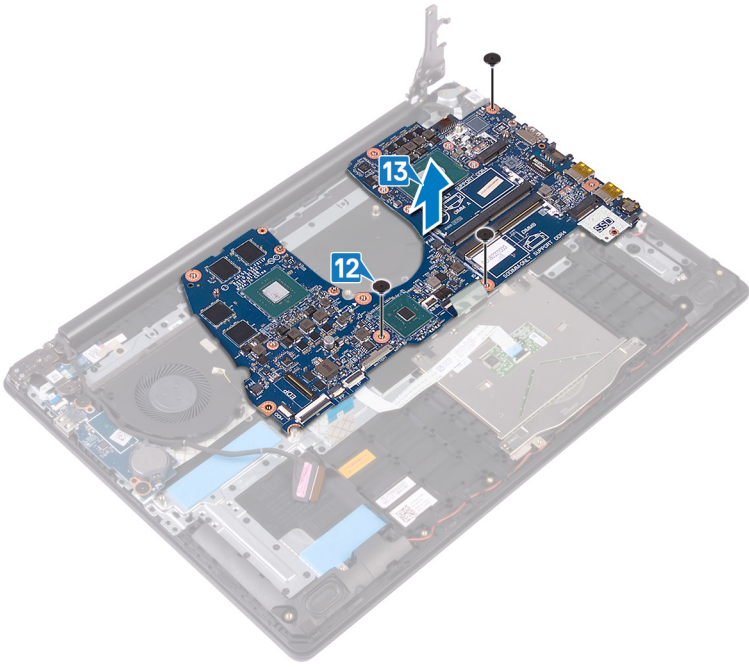

# Replacing the system board

**⚠ WARNING:** Before working inside your computer, read the safety information that shipped with your computer and follow the steps in [Before working inside your computer](#). After working inside your computer, follow the instructions in [After working inside your computer](#). For more safety best practices, see the Regulatory Compliance home page at [www.dell.com/regulatory\\_compliance](http://www.dell.com/regulatory_compliance).

**ⓘ NOTE:** Your computer's Service Tag is stored in the system board. You must enter the Service Tag in the BIOS setup program after you replace the system board.

**ⓘ NOTE:** Replacing the system board removes any changes you have made to the BIOS using the BIOS setup program. You must make the appropriate changes again after you replace the system board.

## Procedure

- 1 Align the screw hole on the system board with the screw hole on the palm rest and keyboard assembly.
- 2 Replace the three screws (M2.5x2.5) that secure the system board to the palm rest and keyboard assembly.

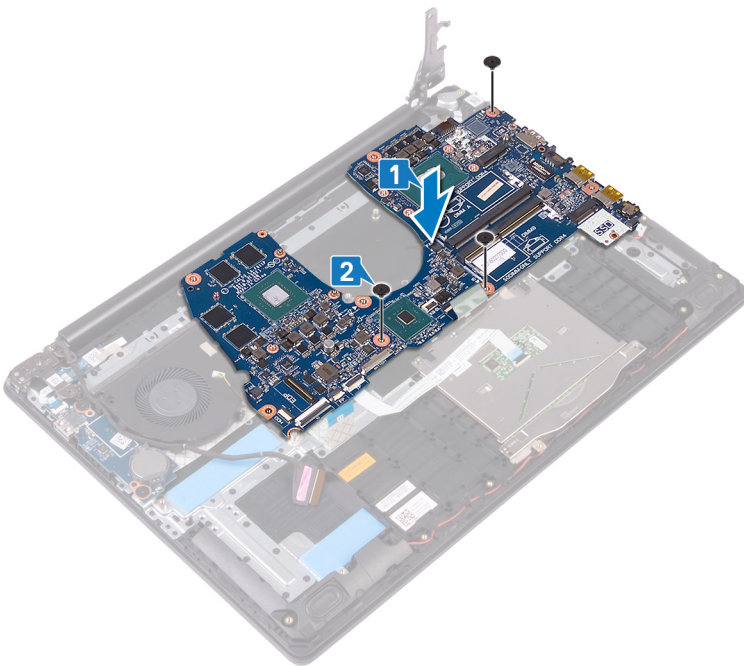

- 3 Connect the power-adaptor port cable.
- 4 Connect the speaker cable.
- 5 Close the latch and connect the keyboard cable.
- 6 Close the latch and connect the keyboard back-light cable.
- 7 Close the latch and connect the touchpad cable.
- 8 Close the latch and connect the fingerprint-reader.
- 9 Close the latch and connect the I/O-board cable.
- 10 Close the latch and connect the hard-drive cable.
- 11 Close the latch and connect the display-assembly cable.
- 12 Connect the graphics-card fan cable to the system board.

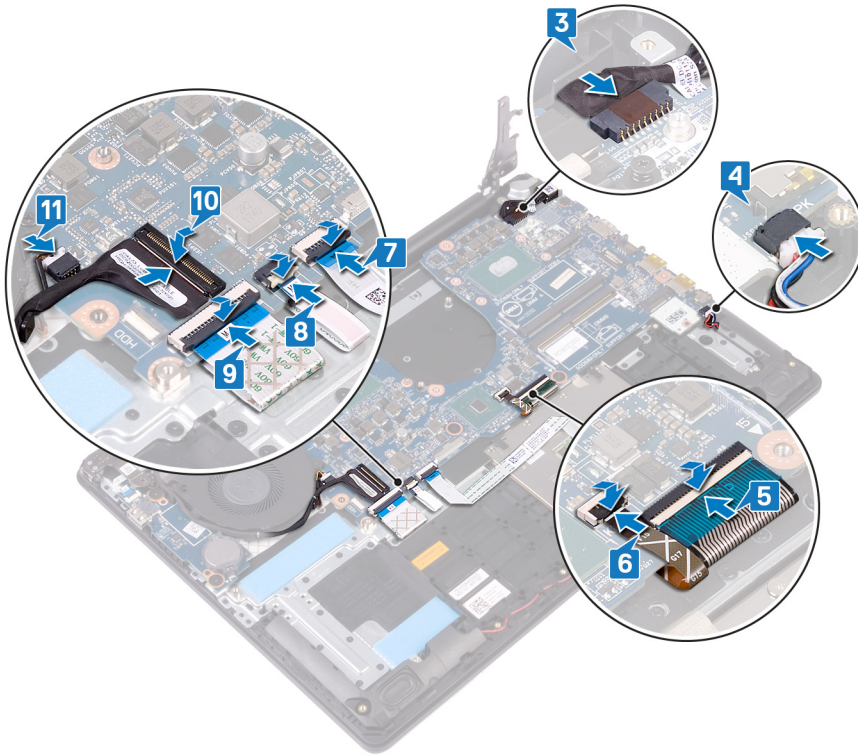

13 Close the right display hinge.

14 Replace the three screws (M2.5x6) that secure the right hinge to the system board.

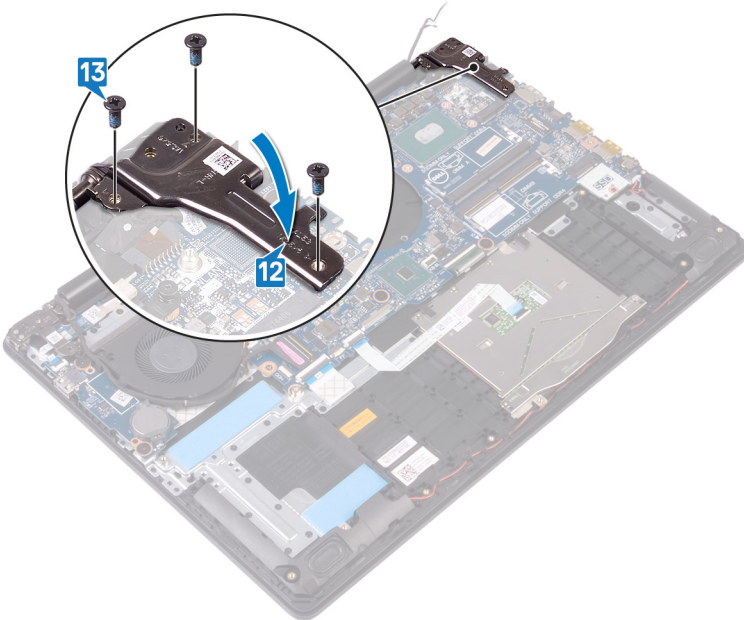

## Post-requisites

- 1 Replace the [heat sink](#).
- 2 Replace the [solid-state drive/Intel Optane](#).
- 3 Replace the [wireless card](#).
- 4 Replace the [memory modules](#).
- 5 Replace the [battery](#).

- 6 Replace the [base cover](#).

## Entering the Service Tag in the BIOS setup program

- 1 Turn on or restart your computer.
- 2 Press F2 when the Dell logo is displayed to enter the BIOS setup program.
- 3 Navigate to the **Main** tab and enter the Service Tag in the **Service Tag Input** field.

 **NOTE:** Service tag is the alphanumeric identifier located at the back side of your computer.

# Removing the power button with fingerprint reader

**⚠ WARNING:** Before working inside your computer, read the safety information that shipped with your computer and follow the steps in [Before working inside your computer](#). After working inside your computer, follow the instructions in [After working inside your computer](#). For more safety best practices, see the Regulatory Compliance home page at [www.dell.com/regulatory\\_compliance](http://www.dell.com/regulatory_compliance).

**ℹ NOTE:** Applicable only for computers that are shipped with fingerprint reader.

## Prerequisites

- 1 Remove the [base cover](#).
- 2 Remove the [battery](#).
- 3 Remove the [solid-state drive/Intel Optane](#).
- 4 Remove the [fan](#).
- 5 Remove the [heat sink](#).
- 6 Remove the [wireless card](#).
- 7 Remove the [power-button board](#).
- 8 Remove the [system board](#).
- 9 Remove the [display assembly](#).

## Procedure

- 1 Peel the fingerprint reader cable off the palm rest and keyboard assembly.
- 2 Remove the screw (M2x2) that secures the power button to the palm rest and keyboard assembly.
- 3 Using a plastic scribe, release the fingerprint-reader board from the palm rest and keyboard assembly.
- 4 Lift the power button, along with its cable, off the palm rest and keyboard assembly.

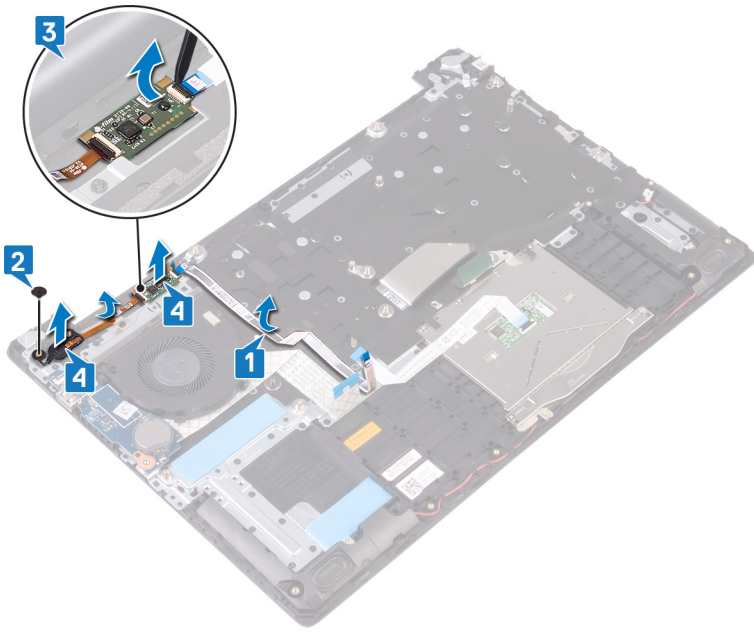



# Replacing the power button with fingerprint reader

**⚠ WARNING:** Before working inside your computer, read the safety information that shipped with your computer and follow the steps in [Before working inside your computer](#). After working inside your computer, follow the instructions in [After working inside your computer](#). For more safety best practices, see the Regulatory Compliance home page at [www.dell.com/regulatory\\_compliance](http://www.dell.com/regulatory_compliance).

**ℹ NOTE:** Applicable only for computers that are shipped with fingerprint reader.

## Procedure

- 1 Using the alignment posts, align the power button on the palm rest and keyboard assembly.
- 2 Slide and place the power button into the slots on the palm rest and keyboard assembly.
- 3 Replace the screw (M2x2) that secures the power button to the palm rest and keyboard assembly.
- 4 Adhere the fingerprint reader cable on the palm rest and keyboard assembly.

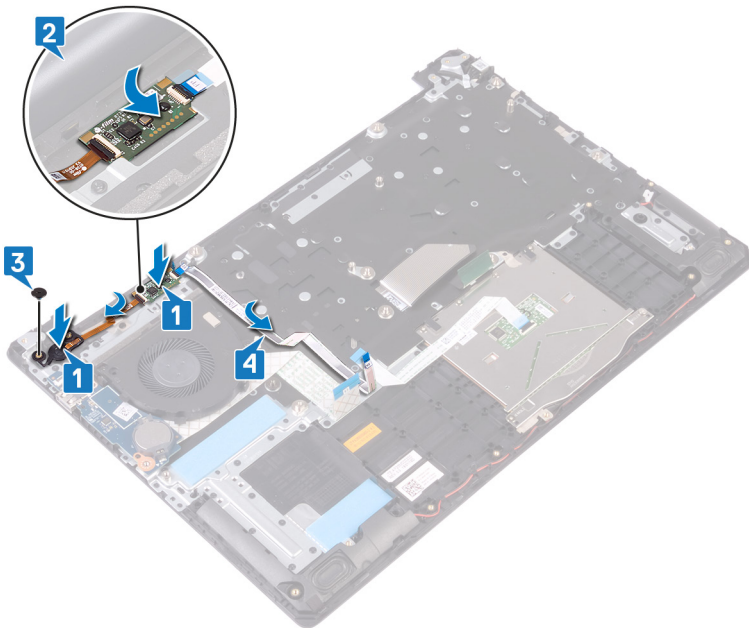

## Post-requisites

- 1 Replace the [display assembly](#).
- 2 Replace the [system board](#).
- 3 Replace the [power-button board](#).
- 4 Replace the [wireless card](#).
- 5 Replace the [heat sink](#).
- 6 Replace the [fan](#).



- 7 Replace the [solid-state drive/Intel Optane](#).
- 8 Replace the [battery](#).
- 9 Replace the [base cover](#).

# Removing the palm-rest and keyboard assembly

**⚠ WARNING:** Before working inside your computer, read the safety information that shipped with your computer and follow the steps in [Before working inside your computer](#). After working inside your computer, follow the instructions in [After working inside your computer](#). For more safety best practices, see the Regulatory Compliance home page at [www.dell.com/regulatory\\_compliance](http://www.dell.com/regulatory_compliance).

## Prerequisites

- 1 Remove the [base cover](#).
- 2 Remove the [battery](#).
- 3 Remove the [fan](#).
- 4 Remove the [solid-state drive/Intel Optane](#).
- 5 Remove the [wireless card](#).
- 6 Remove the [speakers](#).
- 7 Remove the [hard drive](#).
- 8 Remove the [touchpad](#).
- 9 Remove the [power-adaptor port](#).
- 10 Remove the [display assembly](#).
- 11 Remove the [I/O board](#).
- 12 Remove the [power-button board](#) (optional).
- 13 Remove the [system board](#).
- 14 Remove the [power button with fingerprint reader](#) (optional).

## Procedure

After performing the above steps, we are left with the palm rest and keyboard assembly.



# Replacing the palm-rest and keyboard assembly

**⚠ WARNING:** Before working inside your computer, read the safety information that shipped with your computer and follow the steps in [Before working inside your computer](#). After working inside your computer, follow the instructions in [After working inside your computer](#). For more safety best practices, see the Regulatory Compliance home page at [www.dell.com/regulatory\\_compliance](http://www.dell.com/regulatory_compliance).

## Procedure

Place the palm rest and keyboard assembly on a flat surface.

## Post-requisites

- 1 Replace the [power button with fingerprint reader](#) (optional).
- 2 Replace the [system board](#).
- 3 Replace the [power-button board](#).
- 4 Replace the [I/O board](#).
- 5 Replace the [display assembly](#).
- 6 Replace the [power-adapter port](#) (optional).
- 7 Replace the [touchpad](#).
- 8 Replace the [hard drive](#).
- 9 Replace the [speakers](#).
- 10 Replace the [wireless card](#).
- 11 Replace the [solid-state drive/Intel Optane](#).
- 12 Replace the [fan](#).
- 13 Replace the [battery](#).
- 14 Replace the [base cover](#).

# Removing the display bezel

**⚠ WARNING:** Before working inside your computer, read the safety information that shipped with your computer and follow the steps in [Before working inside your computer](#). After working inside your computer, follow the instructions in [After working inside your computer](#). For more safety best practices, see the Regulatory Compliance home page at [www.dell.com/regulatory\\_compliance](http://www.dell.com/regulatory_compliance).

## Prerequisites

- 1 Remove the [base cover](#).
- 2 Remove the [wireless card](#).
- 3 Remove the [display assembly](#).

## Procedure

- 1 Using your fingertips, carefully pry up the display bezel from the top-left outer edge of the display back-cover and antenna assembly.
- 2 Remove the display bezel off the display back-cover and antenna assembly.

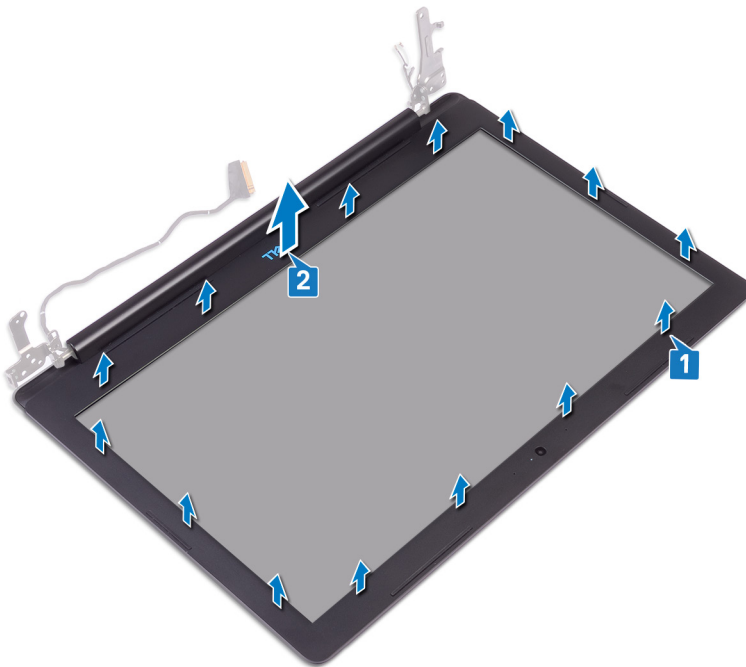

## Replacing the display bezel

**⚠ WARNING:** Before working inside your computer, read the safety information that shipped with your computer and follow the steps in [Before working inside your computer](#). After working inside your computer, follow the instructions in [After working inside your computer](#). For more safety best practices, see the Regulatory Compliance home page at [www.dell.com/regulatory\\_compliance](http://www.dell.com/regulatory_compliance).

### Procedure

- 1 Align the display bezel with the display back-cover and antenna assembly.
- 2 Gently snap the display bezel into place.

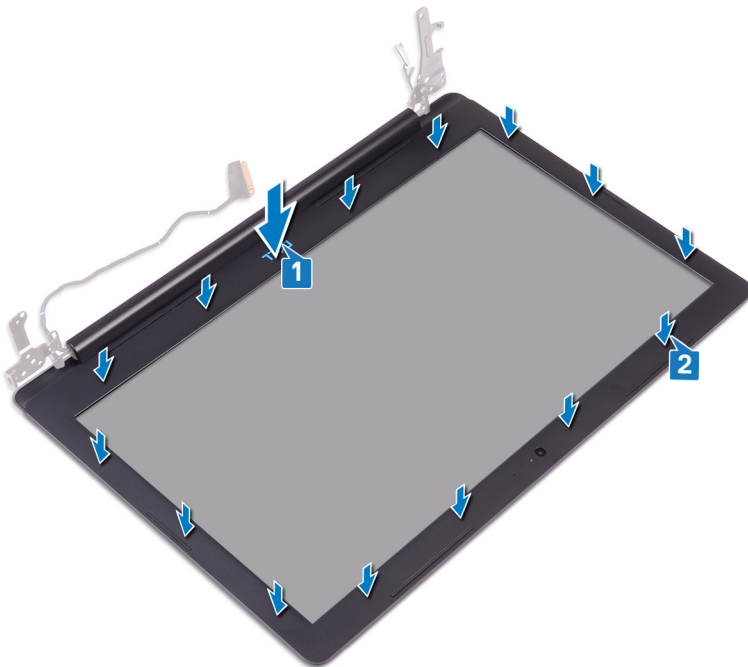

### Post-requisites

- 1 Replace the [display assembly](#).
- 2 Replace the [wireless card](#).
- 3 Replace the [base cover](#).

# Removing the camera

**⚠ WARNING:** Before working inside your computer, read the safety information that shipped with your computer and follow the steps in [Before working inside your computer](#). After working inside your computer, follow the instructions in [After working inside your computer](#). For more safety best practices, see the Regulatory Compliance home page at [www.dell.com/regulatory\\_compliance](http://www.dell.com/regulatory_compliance).

## Prerequisites

- 1 Remove the [base cover](#).
- 2 Remove the [wireless card](#).
- 3 Remove the [display assembly](#).
- 4 Remove the [display bezel](#).

## Procedure

- 1 Using a plastic scribe, gently pry the camera off the display back-cover and antenna assembly.
- 2 Disconnect the camera cable from the camera module.
- 3 Lift the camera module from the display back-cover and antenna assembly.

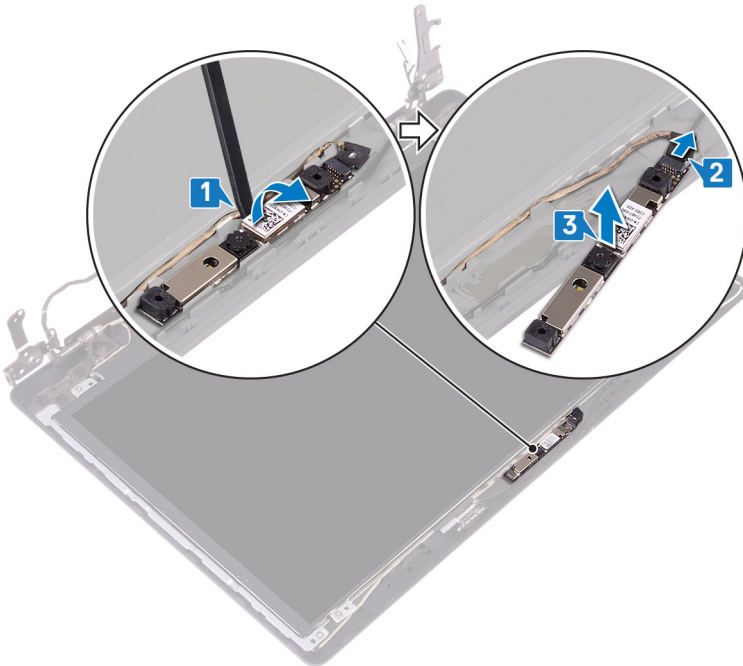

# Replacing the camera

**⚠ WARNING:** Before working inside your computer, read the safety information that shipped with your computer and follow the steps in [Before working inside your computer](#). After working inside your computer, follow the instructions in [After working inside your computer](#). For more safety best practices, see the Regulatory Compliance home page at [www.dell.com/regulatory\\_compliance](http://www.dell.com/regulatory_compliance).

## Procedure

- 1 Connect the camera cable to the camera module.
- 2 Using the alignment post adhere the camera module on the display back-cover and antenna assembly.

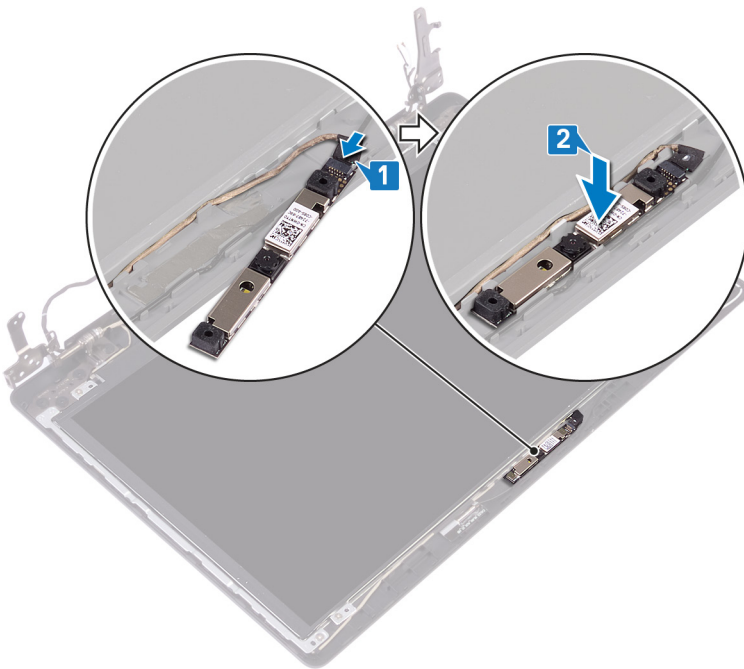

## Post-requisites

- 1 Replace the [display bezel](#).
- 2 Replace the [display assembly](#).
- 3 Replace the [wireless card](#).
- 4 Replace the [base cover](#).



# Removing the display panel

**⚠ WARNING:** Before working inside your computer, read the safety information that shipped with your computer and follow the steps in [Before working inside your computer](#). After working inside your computer, follow the instructions in [After working inside your computer](#). For more safety best practices, see the Regulatory Compliance home page at [www.dell.com/regulatory\\_compliance](http://www.dell.com/regulatory_compliance).

## Prerequisites

- 1 Remove the [base cover](#).
- 2 Remove the [wireless card](#).
- 3 Remove the [display assembly](#).
- 4 Remove the [display bezel](#).

## Procedure

- 1 Remove the four screws (M2x3) that secure the display panel to the display back-cover and antenna assembly.
- 2 Lift the display panel and turn it over.

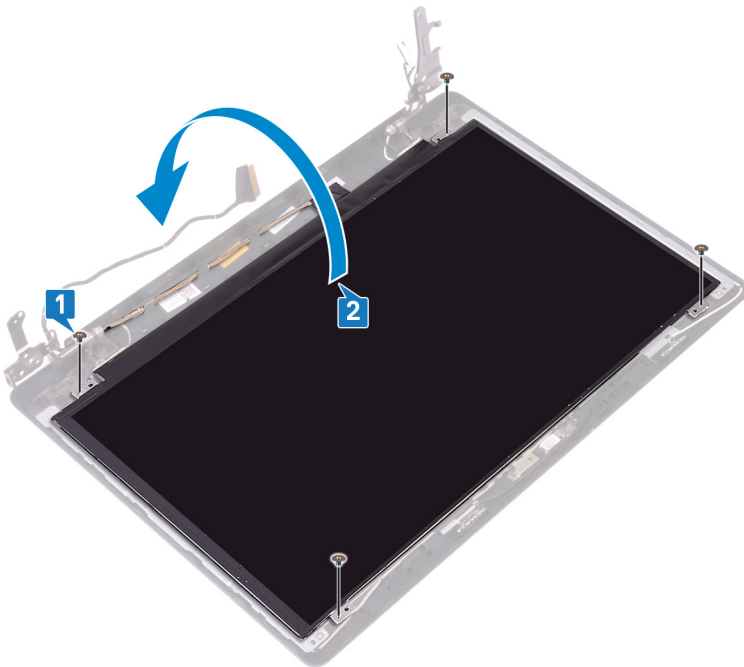

- 3 Peel the tape adhering the display cable to the back of the display panel.
- 4 Open the latch and disconnect the display cable from the display-panel cable connector.
- 5 Lift the display panel away from the display back-cover and antenna assembly.

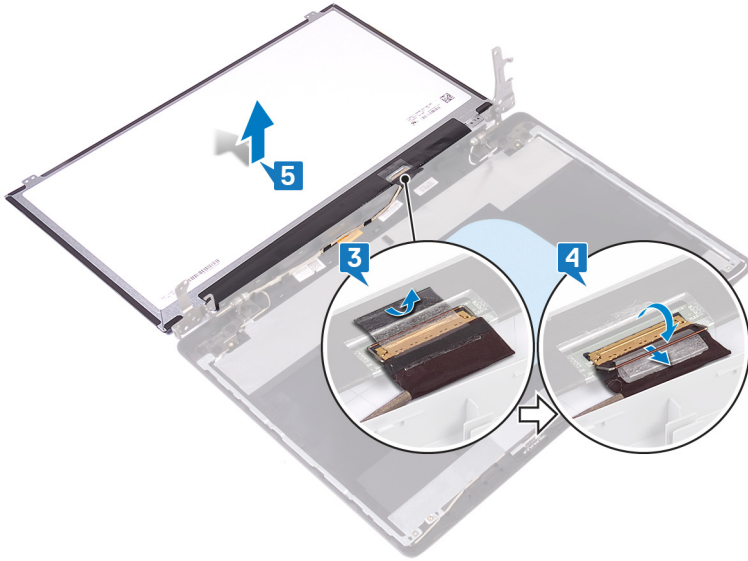

# Replacing the display panel

**⚠ WARNING:** Before working inside your computer, read the safety information that shipped with your computer and follow the steps in [Before working inside your computer](#). After working inside your computer, follow the instructions in [After working inside your computer](#). For more safety best practices, see the Regulatory Compliance home page at [www.dell.com/regulatory\\_compliance](http://www.dell.com/regulatory_compliance).

## Procedure

- 1 Place the display panel on a flat and clean surface.
- 2 Connect the display cable to the connector at the back of the display panel and close the latch to secure the cable.
- 3 Adhere the tape that secures the display cable to the back of the display panel.

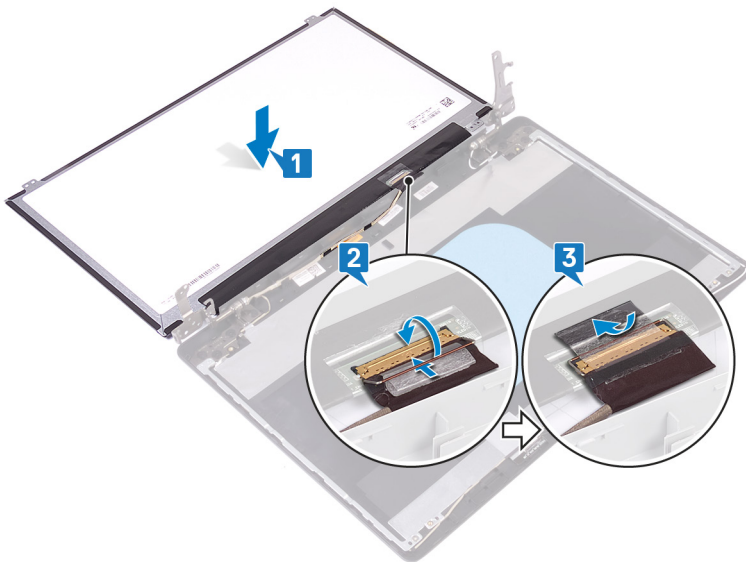

- 4 Place the display panel on the display back-cover and antenna assembly.
- 5 Align the screw holes on the display panel with the screw holes on the display back-cover and antenna assembly.
- 6 Replace the four screws (M2x3) that secure the display panel to the display back-cover and antenna assembly.

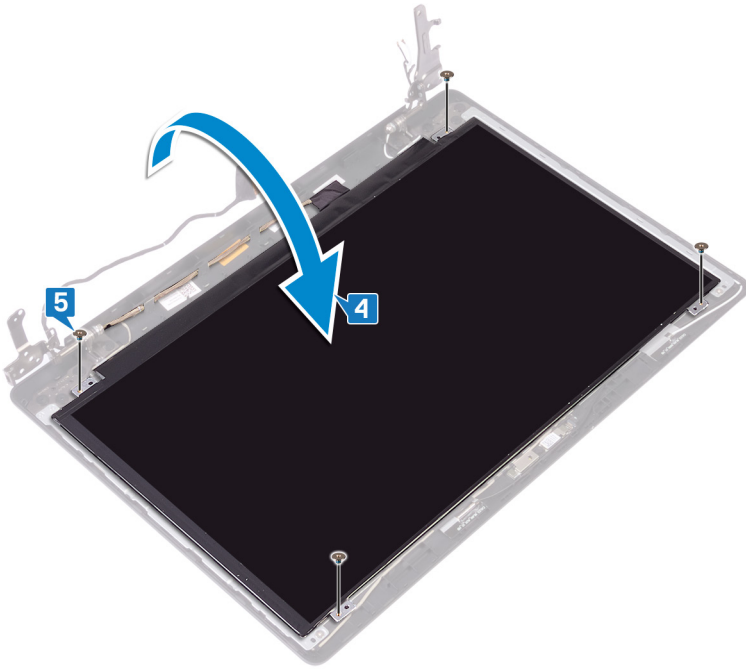

## Post-requisites

- 1 Replace the [display bezel](#).
- 2 Replace the [display assembly](#).
- 3 Replace the [wireless card](#).
- 4 Replace the [base cover](#).

# Removing the display hinges

**⚠ WARNING:** Before working inside your computer, read the safety information that shipped with your computer and follow the steps in [Before working inside your computer](#). After working inside your computer, follow the instructions in [After working inside your computer](#). For more safety best practices, see the Regulatory Compliance home page at [www.dell.com/regulatory\\_compliance](http://www.dell.com/regulatory_compliance).

## Prerequisites

- 1 Remove the [base cover](#).
- 2 Remove the [wireless card](#).
- 3 Remove the [display assembly](#).
- 4 Remove the [display bezel](#).
- 5 Remove the [display panel](#).

## Procedure

- 1 Remove the eight screws (M2.5x2.5) that secure the hinges to the display back-cover and antenna assembly.
- 2 Remove the two screws (M2x2) that secure the hinge brackets to the display back-cover and antenna assembly.
- 3 Lift the hinges and brackets off the display back-cover and antenna assembly.

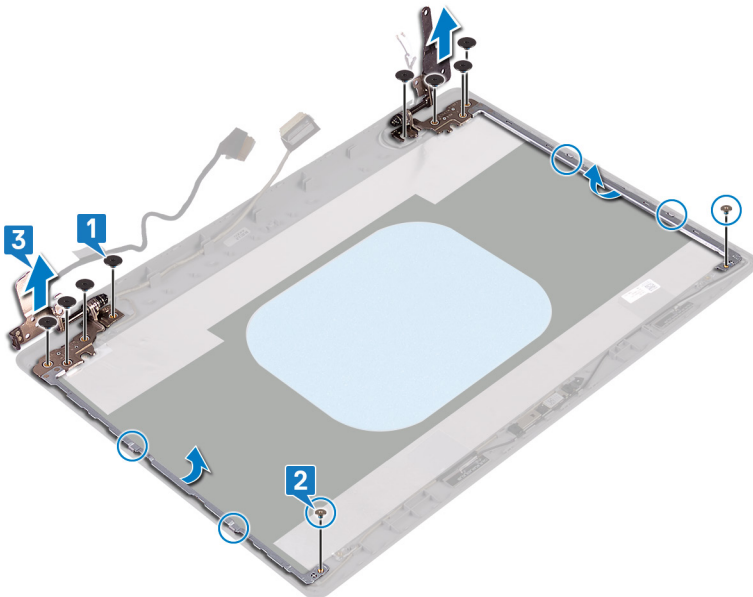

# Replacing the display hinges

**⚠ WARNING:** Before working inside your computer, read the safety information that shipped with your computer and follow the steps in [Before working inside your computer](#). After working inside your computer, follow the instructions in [After working inside your computer](#). For more safety best practices, see the Regulatory Compliance home page at [www.dell.com/regulatory\\_compliance](http://www.dell.com/regulatory_compliance).

## Procedure

- 1 Align the screw holes on the hinges and brackets with the screw holes on the display back-cover and antenna assembly.
- 2 Replace the two screws (M2x2) that secure the hinges to the display back-cover and antenna assembly.
- 3 Replace the eight screws (M2.5x2.5) that secure the hinges to the display back-cover and antenna assembly .

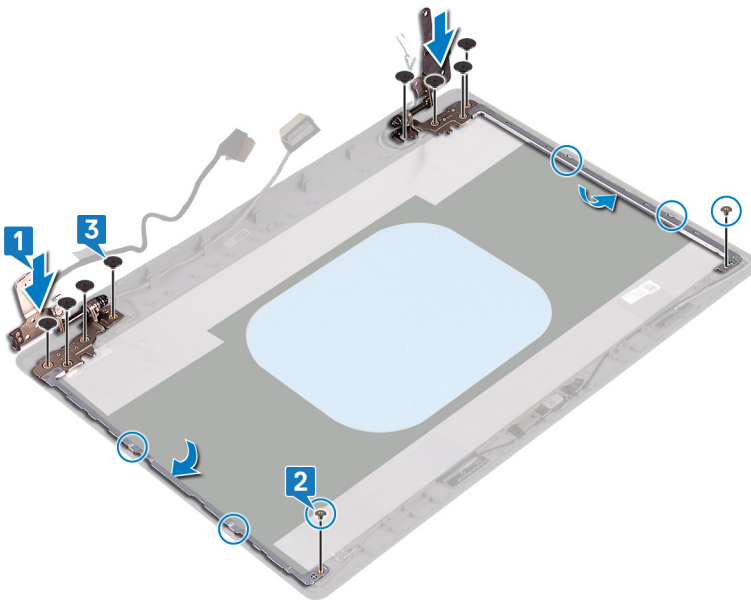

## Post-requisites

- 1 Replace the [display panel](#).
- 2 Replace the [display bezel](#).
- 3 Replace the [display assembly](#).
- 4 Replace the [wireless card](#).
- 5 Replace the [base cover](#).

# Removing the display cable

**⚠ WARNING:** Before working inside your computer, read the safety information that shipped with your computer and follow the steps in [Before working inside your computer](#). After working inside your computer, follow the instructions in [After working inside your computer](#). For more safety best practices, see the Regulatory Compliance home page at [www.dell.com/regulatory\\_compliance](http://www.dell.com/regulatory_compliance).

## Prerequisites

- 1 Remove the [base cover](#).
- 2 Remove the [wireless card](#).
- 3 Remove the [display assembly](#).
- 4 Remove the [display bezel](#).
- 5 Remove the [display panel](#).
- 6 Remove the [display hinges](#).

## Procedure

- 1 Disconnect the camera cable from the camera module.
- 2 Note the display cable routing and remove the cable from the routing guides on the display back-cover and antenna assembly.
- 3 Remove the display cable from the display back-cover and antenna assembly.

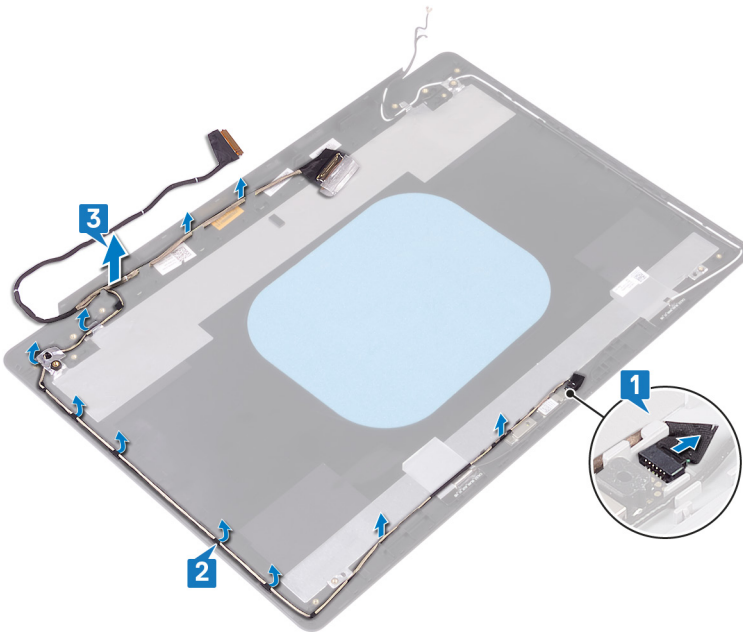

# Replacing the display cable

**⚠ WARNING:** Before working inside your computer, read the safety information that shipped with your computer and follow the steps in [Before working inside your computer](#). After working inside your computer, follow the instructions in [After working inside your computer](#). For more safety best practices, see the Regulatory Compliance home page at [www.dell.com/regulatory\\_compliance](http://www.dell.com/regulatory_compliance).

## Procedure

- 1 Route the display cable on the display back-cover and antenna assembly.
- 2 Route the camera cable through the routing guides on the display back-cover and antenna assembly.
- 3 Slide the camera cable into the connector on the camera module to secure the cable.

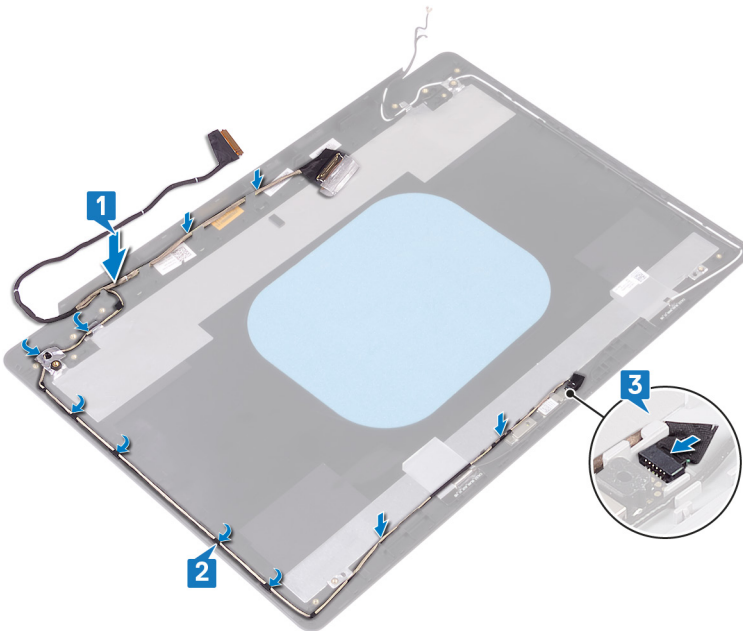

## Post-requisites

- 1 Replace the [display hinges](#).
- 2 Replace the [display panel](#).
- 3 Replace the [display bezel](#).
- 4 Replace the [display assembly](#).
- 5 Replace the [wireless card](#).
- 6 Replace the [base cover](#).



# Removing the display back-cover and antenna assembly

**⚠ WARNING:** Before working inside your computer, read the safety information that shipped with your computer and follow the steps in [Before working inside your computer](#). After working inside your computer, follow the instructions in [After working inside your computer](#). For more safety best practices, see the Regulatory Compliance home page at [www.dell.com/regulatory\\_compliance](http://www.dell.com/regulatory_compliance).

## Prerequisites

- 1 Remove the [base cover](#).
- 2 Remove the [wireless card](#).
- 3 Remove the [display assembly](#).
- 4 Remove the [display bezel](#).
- 5 Remove the [camera](#).
- 6 Remove the [display panel](#).
- 7 Remove the [display hinges](#).
- 8 Remove the [display cable](#).

## Procedure

After performing all the above steps, we are left with the display back-cover and antenna assembly.

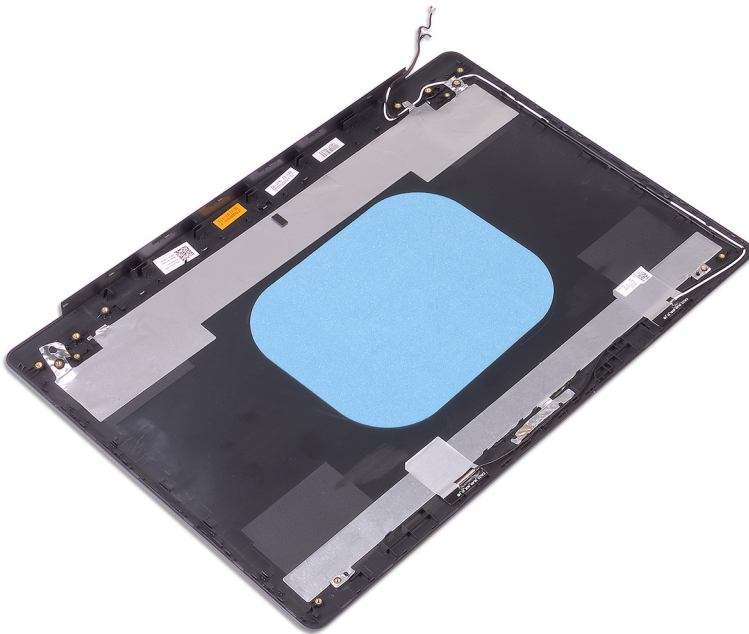

# Replacing the display back-cover and antenna assembly

**⚠ WARNING:** Before working inside your computer, read the safety information that shipped with your computer and follow the steps in [Before working inside your computer](#). After working inside your computer, follow the instructions in [After working inside your computer](#). For more safety best practices, see the Regulatory Compliance home page at [www.dell.com/regulatory\\_compliance](http://www.dell.com/regulatory_compliance).

## Procedure

Place the display back-cover and antenna assembly on a clean and flat surface.

## Post-requisites

- 1 Replace the [display cable](#).
- 2 Replace the [display hinges](#).
- 3 Replace the [display panel](#).
- 4 Replace the [camera](#).
- 5 Replace the [display bezel](#).
- 6 Replace the [display assembly](#).
- 7 Replace the [wireless card](#).
- 8 Replace the [base cover](#).

## Downloading drivers

### Downloading the audio driver

- 1 Turn on your computer.
- 2 Go to [www.dell.com/support](http://www.dell.com/support).
- 3 Click **Product support**, enter the Service Tag of your computer, and then click **Submit**.  
 ⓘ **NOTE: If you do not have the Service Tag, use the auto-detect feature or manually browse for your computer model.**
- 4 Click **Drivers & downloads > Find it myself**.
- 5 Scroll down the page, and expand **Audio**.
- 6 Click **Download** to download the audio driver for your computer.
- 7 After the download is complete, navigate to the folder where you saved the audio driver file.
- 8 Double-click the audio driver file icon and follow the instructions on the screen to install the driver.

### Downloading the graphics driver

- 1 Turn on your computer.
- 2 Go to [www.dell.com/support](http://www.dell.com/support).
- 3 Click **Product support** enter the Service Tag of your computer, and then click **Submit**.  
 ⓘ **NOTE: If you do not have the Service Tag, use the auto-detect feature or manually browse for your computer model.**
- 4 Click **Drivers & downloads > Find it myself**.
- 5 Scroll down the page, and expand **Video**.
- 6 Click **Download** to download the graphics driver for your computer.
- 7 After the download is complete, navigate to the folder where you saved the graphics driver file.
- 8 Double-click the graphics driver file icon, and follow the instructions on the screen.

**Table 3. Display adapter in device manager**

#### Before driver installation

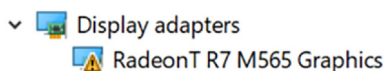

#### After driver installation



### Downloading the USB 3.0 driver

- 1 Turn on your computer.
- 2 Go to [www.dell.com/support](http://www.dell.com/support).
- 3 Click **Product support** enter the Service Tag of your computer, and then click **Submit**.  
 ⓘ **NOTE: If you do not have the Service Tag, use the auto-detect feature or manually browse for your computer model.**
- 4 Click **Drivers & downloads > Find it myself**.
- 5 Scroll down the page and expand **Chipset**.
- 6 Click **Download** to download the USB 3.0 driver for your computer.
- 7 After the download is complete, navigate to the folder where you saved the USB 3.0 driver file.

- 8 Double-click the driver file icon and follow the instructions on screen.

## Downloading the Wi-Fi driver

- 1 Turn on your computer.
- 2 Go to [www.dell.com/support](http://www.dell.com/support).
- 3 Click **Product support** enter the Service Tag of your computer, and then click **Submit**.

 **NOTE: If you do not have the Service Tag, use the auto-detect feature or manually browse for your computer model.**

- 4 Click **Drivers & downloads > Find it myself**.
- 5 Scroll down the page, and expand **Network**.
- 6 Click **Download** to download the Wi-Fi driver for your computer.
- 7 After the download is complete, navigate to the folder where you saved the Wi-Fi driver file.
- 8 Double-click the driver file icon and follow the on-screen instructions to install the driver.

## Downloading the media-card reader driver

- 1 Turn on your computer.
- 2 Go to [www.dell.com/support](http://www.dell.com/support).
- 3 Click **Product support**, enter the Service Tag of your computer, and then click **Submit**.

 **NOTE: If you do not have the Service Tag, use the auto-detect feature or manually browse for your computer model.**

- 4 Click **Drivers & downloads > Find it myself**.
- 5 Scroll down the page, and expand **Chipset**.
- 6 Click **Download** to download the media-card reader driver for your computer.
- 7 After the download is complete, navigate to the folder where you saved the card reader driver file.
- 8 Double-click the card reader driver file icon, and follow the instructions on the screen.

## Downloading the chipset driver

- 1 Turn on your computer.
- 2 Go to [www.dell.com/support](http://www.dell.com/support).
- 3 Click **Product support**, enter the Service Tag of your computer, and then click **Submit**.

 **NOTE: If you do not have the Service Tag, use the auto-detect feature or manually browse for your computer model.**

- 4 Click **Drivers & downloads > Find it myself**.
- 5 Scroll down the page and expand **Chipset**.
- 6 Click **Download** to download the chipset driver for your computer.
- 7 After the download is complete, navigate to the folder where you saved the chipset driver file.
- 8 Double-click the chipset driver file icon and follow the instructions on the screen.

## Downloading the network driver

- 1 Turn on your computer.
- 2 Go to [www.dell.com/support](http://www.dell.com/support).
- 3 Click **Product support** enter the Service Tag of your computer and click **Submit**.

 **NOTE: If you do not have the Service Tag, use the auto-detect feature or manually browse for your computer model.**

- 4 Click **Drivers & downloads > Find it myself**.
- 5 Scroll down the page and expand **Network**.
- 6 Click **Download** to download the network driver for your computer.
- 7 Save the file, and after the download is complete, navigate to the folder where you saved the network driver file.

8 Double-click the network driver file icon and follow the instructions on screen.

# System setup

**NOTE:** Depending on the computer and its installed devices, the items listed in this section may or may not be displayed.

## Boot Sequence

Boot Sequence allows you to bypass the System Setup–defined boot device order and boot directly to a specific device (for example: optical drive or hard drive). During the Power-on Self Test (POST), when the Dell logo appears, you can:

- Access System Setup by pressing F2 key
- Bring up the one-time boot menu by pressing F12 key

The one-time boot menu displays the devices that you can boot from including the diagnostic option. The boot menu options are:

- Removable Drive (if available)
- STXXXX Drive

**NOTE:** XXX denotes the SATA drive number.

- Optical Drive (if available)
- SATA Hard Drive (if available)
- Diagnostics

**NOTE:** Choosing Diagnostics, will display the ePSA diagnostics screen.

The boot sequence screen also displays the option to access the System Setup screen.

## Navigation keys

**NOTE:** For most of the System Setup options, changes that you make are recorded but do not take effect until you restart the system.

Keys	Navigation
Up arrow	Moves to the previous field.
Down arrow	Moves to the next field.
Enter	Selects a value in the selected field (if applicable) or follow the link in the field.
Spacebar	Expands or collapses a drop-down list, if applicable.
Tab	Moves to the next focus area.
	<b>NOTE:</b> For the standard graphics browser only.
Esc	Moves to the previous page until you view the main screen. Pressing Esc in the main screen displays a message that prompts you to save any unsaved changes and restarts the system.

# BIOS overview

**⚠ CAUTION:** Unless you are an expert computer user, do not change the settings in the BIOS Setup program. Certain changes can make your computer work incorrectly.

**📌 NOTE:** Before you change BIOS Setup program, it is recommended that you write down the BIOS Setup program screen information for future reference.

Use the BIOS Setup program for the following purposes:

- Get information about the hardware installed in your computer, such as the amount of RAM and the size of the hard drive.
- Change the system configuration information.
- Set or change a user-selectable option, such as the user password, type of hard drive installed, and enabling or disabling base devices.

## Entering BIOS setup program

- 1 Turn on (or restart) your computer.
- 2 During POST, when the DELL logo is displayed, watch for the F2 prompt to appear, and then press F2 immediately.

**📌 NOTE:** The F2 prompt indicates that the keyboard is initialized. This prompt can appear very quickly, so you must watch for it, and then press F2. If you press F2 before the F2 prompt, this keystroke is lost. If you wait too long and the operating system logo appears, continue to wait until you see the desktop. Then, turn off your computer and try again.

## Enabling or disabling the USB in BIOS setup program

- 1 Turn on or restart your computer.
- 2 Press F2 when the Dell logo is displayed on the screen to enter the BIOS setup program.  
The BIOS setup program is displayed.
- 3 On the left pane, select **Settings > System Configuration > USB Configuration**.  
The USB configuration is displayed on the right pane.
- 4 Select or clear the **Enable External USB Port** check box to enable or disable it respectively.
- 5 Save the BIOS setup program settings and exit.

## Identifying the hard drive in BIOS setup program

- 1 Turn on or restart your computer.
- 2 Press F2 when the Dell logo is displayed on the screen to enter the BIOS setup program.  
A list of hard drives is displayed under the **System Information** in the **General** group.

## Checking the system memory in BIOS setup program

- 1 Turn on or restart your computer.
- 2 Press F2 when the Dell logo is displayed on the screen to enter the BIOS setup program.
- 3 On the left pane, select **Settings > General > System Information**.  
The memory information is displayed on the right pane.

## System setup options

**📌 NOTE:** Depending on this computer and its installed devices, the items listed in this section may or may not appear.

**Table 4. System setup options—System information menu**

**General-System Information**

---

**System Information**

BIOS Version	Displays the BIOS version number.
Service Tag	Displays the Service Tag of the computer.
Asset Tag	Displays the Asset Tag of the computer.
Ownership Tag	Displays the ownership tag of the computer.
Manufacture Date	Displays the manufacture date of the computer.
Ownership Date	Displays the ownership date of the computer.
Express Service Code	Displays the express service code of the computer.

**Memory Information**

Memory Installed	Displays the total computer memory installed.
Memory Available	Displays the total computer memory available.
Memory Speed	Displays the memory speed.
Memory Channel Mode	Displays single or dual channel mode.
Memory Technology	Displays the technology used for the memory.
DIMM A Size	Displays the DIMM A memory size.
DIMM B Size	Displays the DIMM B memory size.

**Processor Information**

Processor Type	Displays the processor type.
Core Count	Displays the number of cores on the processor.
Processor ID	Displays the processor identification code.
Current Clock Speed	Displays the current processor clock speed.
Minimum Clock Speed	Displays the minimum processor clock speed.
Maximum Clock Speed	Displays the maximum processor clock speed.
Processor L2 Cache	Displays the processor L2 Cache size.
Processor L3 Cache	Displays the processor L3 Cache size.
HT Capable	Displays whether the processor is HyperThreading (HT) capable.
64-Bit Technology	Displays whether 64-bit technology is used.

**Device Information**

Primary HDD	Displays the primary hard drive information of the computer.
M.2 SATA SSD	Displays the M.2 SATA SSD device information of the computer.
M.2 PCIe SSD-0	Displays the M.2 PCIe SSD information of the computer.
LOM MAC Address	Displays the LOM MAC address of the computer.
Video Controller	Displays the video controller type of the computer.
dGPU Video Controller	Displays the discrete graphics information of the computer.
Video BIOS Version	Displays the video BIOS version of the computer.
Video Memory	Displays the video memory information of the computer.
Panel Type	Displays the Panel Type of the computer.
Native Resolution	Displays the native resolution of the computer.



## General-System Information

---

Audio Controller	Displays the audio controller information of the computer.
Wi-Fi Device	Displays the wireless device information of the computer.
Bluetooth Device	Displays the bluetooth device information of the computer.
<b>Battery Information</b>	Displays the battery health information.
<b>Boot Sequence</b>	
Boot Sequence	Displays the boot sequence.
Boot List Option	Displays the available boot options.
<b>Advanced Boot Options</b>	
Enable Legacy Option ROMs	Enable or disable the Legacy Option ROMs.
Enable Attempt Legacy Boot	Enable or disable Legacy Boot.
<b>UEFI Boot Path Security</b>	Enable or disable the system to prompt the user to enter the Admin password when booting a UEFI boot path from the F12 boot menu.
<b>Date/Time</b>	Displays the current date in MM/DD/YY format and current time in HH:MM:SS AM/PM format.

**Table 5. System setup options—System Configuration menu**

## System Configuration

---

<b>Integrated NIC</b>	Controls the on-board LAN controller.
Enable UEFI Network Stack	Enable or disable UEFI Network Stack.
<b>SATA Operation</b>	Configure operating mode of the integrated SATA hard drive controller.
<b>Drives</b>	Enable or disable various drives on board.
<b>SMART Reporting</b>	Enable or disable SMART Reporting during system startup.
<b>USB Configuration</b>	
Enable Boot Support	Enable or disable booting from USB mass storage devices such as external hard drive, optical drive, and USB drive.
Enable External USB Port	Enable or disable booting from USB mass storage devices connected to external USB port.
<b>Thunderbolt Adapter Configuration</b>	Enable or disable Thunderbolt technology support.
<b>Audio</b>	Enable or disable the integrated audio controller.
<b>Keyboard Illumination</b>	Enables you to choose the operating mode of the keyboard illumination feature.
<b>Keyboard Backlight Timeout on AC</b>	When the backlight is enabled, this feature defines the timeout value for the keyboard backlight when an AC adapter is plugged into the computer.
<b>Keyboard Backlight Timeout on Battery</b>	When the backlight is enabled, this feature defines the timeout value for the keyboard backlight when the computer is running only on battery power.
<b>Miscellaneous Devices</b>	Enable or disable various onboard devices.

**Table 6. System setup options—Video menu**

## Video

---

LCD Brightness	Set the panel brightness independently for Battery and AC power.
----------------	--

**Table 7. System setup options—Security menu****Security**

Admin Password	Set, change, or delete the administrator password.
System Password	Set, change, or delete the system password.
Internal HDD-0 Password	Set, change, or delete the internal hard-disk drive password.
Strong Password	Enable or disable strong passwords.
Password Configuration	Control the minimum and maximum number of characters allowed for Admin and System passwords.
Password Bypass	Bypass the System (Boot) Password and the internal HDD password prompts during a system restart.
Password Change	Enable or disable changes to the System and Hard Disk passwords when an administrator password is set.
Non-Admin Setup Changes	Determines whether changes to the setup option are permitted when an administrator password is set.
UEFI Capsule Firmware Updates	Enable or disable BIOS updates through UEFI capsule update packages.
PTT Security	Enable or disable Platform Trust Technology (PTT) visibility to the operating system.
Computrace(R)	Enable or disable the BIOS module interface of the optional Computrace(R) Service from Absolute Software.
Admin Setup Lockout	Enable to prevent users from entering Setup when an Admin Password is set.
Master Password Lockout	Disables the master password support. Hard Disk passwords need to be cleared before changing the setting.

**Table 8. System setup options—Secure Boot menu****Secure Boot**

Secure Boot Enable	Enable or disable the secure boot feature.
Secure Boot Mode	Modifies the behavior of Secure Boot to allow evaluation or enforcement of UEFI driver signatures.
<b>Expert Key Management</b>	
Expert Key Management	Enable or disable Expert Key Management.
Custom Mode Key Management	Select the custom values for expert key management.

**Table 9. System setup options—Intel Software Guard Extensions menu****Intel Software Guard Extensions**

Intel SGX Enable	Enable or disable Intel Software Guard Extensions.
Enclave Memory Size	Set the Intel Software Guard Extensions Enclave Reserve Memory Size.

**Performance**

Multi Core Support	Enable multiple cores. Default: Enabled.
Intel SpeedStep	Enable or disable Intel Speedstep Technology. Default: Enabled.

**i** **NOTE:** If enabled, the processor clock speed and core voltage are adjusted dynamically based on the processor load.

## Intel Software Guard Extensions

---

C-States Control	Enable or disable additional processor sleep states. Default: Enabled.
Intel TurboBoost	Enable or disable Intel TurboBoost mode of the processor. Default: Enabled.
HyperThread control	Enable or disable HyperThreading in the processor. Default: Enabled.

## Power Management

AC Behavior	Enables the system to turn on automatically, when AC power is supplied.
Enable Intel Speed Shift Technology	Enable or disable Intel Speed Shift Technology.
Auto On Time	Enable to set the computer to turn on automatically every day or on a preselected date and time. This option can be configured only if the Auto On Time is set to Everyday, Weekdays or Selected Days. Default: Disabled.
USB Wake Support	Enable the USB devices to wake the computer from Standby.
Advanced Battery Charge Configuration	Enable Advanced Battery Charge Configuration from the beginning of the day to a specified work period.
Primary Battery Charge Configuration	Set the primary battery charge settings with a preselected custom charge start and stop. Default: Adaptive.

## POST Behavior

Adapter Warnings	Enable adapter warnings. Default: Enabled.
Numlock Enable	Enables the NumLock function when computer boots.
Fn Lock Options	Enable or disable the Fn lock mode.
Fastboot	Enable to set the speed of the boot process. Default: Thorough.
Extend BIOS POST Time	Configure additional pre-boot delay.
Full Screen Logo	Enable or disable to display full screen logo.
Warnings and Errors	Sets the boot process to pause when Warnings or Errors are detected.
Sign of Life Indication	Enable or disable to indicate during POST time that the power button press is acknowledged in a manner the user can either hear or feel.

**Table 10. System setup options—Virtualization Support menu**

## Virtualization Support

---

Virtualization	Specify whether a Virtual Machine Monitor (VMM) can utilize the additional hardware capabilities provided by Intel Virtualization Technology.
VT for Direct I/O	Specify whether a Virtual Machine Monitor (VMM) can utilize the additional hardware capabilities provided by Intel Virtualization Technology for Direct I/O.

**Table 11. System setup options—Wireless menu**

**Wireless**

---

Wireless Switch	Determine which wireless devices can be controlled by the Wireless Switch.
Wireless Device Enable	Enable or disable internal wireless devices.

**Table 12. System setup options—Maintenance menu**

**Maintenance**

---

Service Tag	Display the system's Service Tag.
Asset Tag	Create a system Asset Tag.
BIOS Downgrade	Control flashing of the system firmware to previous revisions.
Data Wipe	Enable to securely erase data from all internal storage devices.
BIOS Recovery	Enable the user to recover from certain corrupted BIOS conditions from a recovery file on the user primary hard drive or an external USB key.

**Table 13. System setup options—System Logs menu**

**System Logs**

---

BIOS Events	Display BIOS events.
Thermal Events	Display Thermal events.
Power Events	Display Power events.

**Table 14. System setup options—SupportAssist System Resolution menu**

**SupportAssist System Resolution**

---

Auto OS Recovery Threshold	Control the automatic boot flow for SupportAssist System Resolution Console and for Dell OS Recovery tool.
SupportAssist OS Recovery	Enable or disable the boot flow for SupportAssist OS Recovery tool in the even of certain system errors.

# System and setup password

**Table 15. System and setup password**

Password type	Description
System password	Password that you must enter to log on to your system.
Setup password	Password that you must enter to access and make changes to the BIOS settings of your computer.

You can create a system password and a setup password to secure your computer.

**⚠ CAUTION:** The password features provide a basic level of security for the data on your computer.

**⚠ CAUTION:** Anyone can access the data stored on your computer if it is not locked and left unattended.

**ℹ NOTE:** System and setup password feature is disabled.

## Assigning a system password and setup password

You can assign a new **System Password** only when the status is in **Not Set**.

To enter the system setup, press F2 immediately after a power-on or re-boot.

- In the **System BIOS** or **System Setup** screen, select **Security** and press Enter.  
The **Security** screen is displayed.
- Select **System Password** and create a password in the **Enter the new password** field.  
Use the following guidelines to assign the system password:
  - A password can have up to 32 characters.
  - The password can contain the numbers 0 through 9.
  - Only lower case letters are valid, upper case letters are not allowed.
  - Only the following special characters are allowed: space, ("), (+), (,), (-), (.), (/), (;), ([), (\), (]), (^).
- Type the system password that you entered earlier in the **Confirm new password** field and click **OK**.
- Press Esc and a message prompts you to save the changes.
- Press Y to save the changes.  
The computer reboots.

## Deleting or changing an existing system setup password

Ensure that the **Password Status** is Unlocked (in the System Setup) before attempting to delete or change the existing System and/or Setup password. You cannot delete or change an existing System or Setup password, if the **Password Status** is Locked.

To enter the System Setup, press F2 immediately after a power-on or reboot.

- In the **System BIOS** or **System Setup** screen, select **System Security** and press Enter.

The **System Security** screen is displayed.

- 2 In the **System Security** screen, verify that **Password Status** is **Unlocked**.
- 3 Select **System Password**, alter or delete the existing system password and press Enter or Tab.
- 4 Select **Setup Password**, alter or delete the existing setup password and press Enter or Tab.

 **NOTE: If you change the System and/or Setup password, re-enter the new password when promoted. If you delete the System and/or Setup password, confirm the deletion when promoted.**

- 5 Press Esc and a message prompts you to save the changes.
- 6 Press Y to save the changes and exit from System Setup.

The computer reboot.

## Clearing CMOS settings

 **CAUTION: Clearing CMOS settings will reset the BIOS settings on your computer.**

- 1 Remove the [base cover](#).
- 2 Disconnect the battery cable from the system board.
- 3 Remove the [coin-cell battery](#).
- 4 Wait for one minute.
- 5 Replace the [coin-cell battery](#).
- 6 Connect the battery cable to the system board.
- 7 Replace the [base cover](#).

## Clearing forgotten passwords

Contact Dell technical support to clear the forgotten passwords, see [www.dell.com/contactdell](http://www.dell.com/contactdell).

## Troubleshooting

### Flashing the BIOS

You may need to flash (update) the BIOS when an update is available or when you replace the system board.

Follow these steps to flash the BIOS:

- 1 Turn on your computer.
- 2 Go to [www.dell.com/support](http://www.dell.com/support).
- 3 Click **Product support**, enter the Service Tag of your computer, and then click **Submit**.

**NOTE:** If you do not have the Service Tag, use the auto-detect feature or manually browse for your computer model.

- 4 Click **Drivers & downloads > Find it myself**.
- 5 Select the operating system installed on your computer.
- 6 Scroll down the page and expand **BIOS**.
- 7 Click **Download** to download the latest version of the BIOS for your computer.
- 8 After the download is complete, navigate to the folder where you saved the BIOS update file.
- 9 Double-click the BIOS update file icon and follow the instructions on the screen.

### Flashing BIOS (USB key)

- 1 Follow the procedure from step 1 to step 7 in "Flashing the BIOS" to download the latest BIOS setup program file.
- 2 Create a bootable USB drive. For more information see the knowledge base article [SLN143196](https://www.dell.com/support/SLN143196) at [www.dell.com/support](http://www.dell.com/support).
- 3 Copy the BIOS setup program file to the bootable USB drive.
- 4 Connect the bootable USB drive to the computer that needs the BIOS update.
- 5 Restart the computer and press **F12** when the Dell logo is displayed on the screen.
- 6 Boot to the USB drive from the **One Time Boot Menu**.
- 7 Type the BIOS setup program filename and press **Enter**.
- 8 The **BIOS Update Utility** appears. Follow the instructions on the screen to complete the BIOS update.

### Intel Optane memory (Optional)

Disable Intel Optane before removing or replacing Intel Optane and/or a SATA hard drive. Enable Intel Optane after replacing Intel Optane and/or a SATA hard drive.

### Enabling Intel Optane memory

- 1 On the taskbar, click the search box, and then type `Intel Rapid Storage Technology`.
- 2 Click **Intel Rapid Storage Technology**.  
The **Intel Rapid Storage Technology** window is displayed.
- 3 On the **Status** tab, click **Enable** to enable the Intel Optane memory.
- 4 On the warning screen, select a compatible fast drive, and then click **Yes** to continue enabling Intel Optane memory.
- 5 Click **Intel Optane memory > Reboot** to complete enabling your Intel Optane memory.

**NOTE:** Applications may take up to three subsequent launches after enablement to see the full performance benefits.

## Disabling Intel Optane memory

**⚠ CAUTION:** Do not try to remove the Intel Rapid Storage Technology driver after disabling Intel Optane memory, it will result in a blue screen error. The Intel Rapid Storage Technology user interface can be removed without uninstalling the driver.

**📌 NOTE:** Disabling Intel Optane memory is required before removing the SATA storage device accelerated by the Intel Optane memory or the Intel Optane memory module from the system.

- 1 On the taskbar, click the search box, and then type `Intel Rapid Storage Technology`.
- 2 Click **Intel Rapid Storage Technology**.  
The **Intel Rapid Storage Technology** window is displayed.
- 3 On the **Intel Optane memory** tab, click **Disable** to disable the Intel Optane memory.
- 4 Click **Yes** if you accept the warning.  
The disabling progress is displayed.
- 5 Click **Reboot** to complete disabling your Intel Optane memory and restart your computer.

## Reinstall Windows using a USB recovery drive

**⚠ CAUTION:** This process formats the hard drive and removes all data on your computer. Ensure that you back up data on your computer before beginning this task.

**📌 NOTE:** Before reinstalling Windows, ensure your computer has more than 2 GB of memory and more than 32 GB of storage space.

**📌 NOTE:** This process may take up to an hour to complete and your computer will restart during the recovery process.

- 1 Connect the USB recovery drive to your computer.
- 2 Restart your computer.
- 3 Press F12 after the Dell logo is displayed on the screen to access the boot menu.  
A **Preparing one-time boot menu** message appears.
- 4 After the boot menu loads, select the USB recovery device under **UEFI BOOT**.  
The system reboots and a screen to **Choose the keyboard layout** is displayed.
- 5 Choose your keyboard layout.
- 6 In the **Choose an option** screen, click **Troubleshoot**.
- 7 Click **Recover from a drive**.
- 8 Choose one of the following options:
  - **Just remove my files** to do a quick format.
  - **Fully clean the drive** to do a complete format.
- 9 Click **Recover** to start the recovery process.

## Enhanced Pre-Boot System Assessment (ePSA) diagnostics

**⚠ CAUTION:** Use the ePSA diagnostics to test only your computer. Using this program with other computers may cause invalid results or error messages.

The ePSA diagnostics (also known as system diagnostics) performs a complete check of your hardware. The ePSA is embedded with the BIOS and is launched by the BIOS internally. The embedded system diagnostics provides a set of options for particular devices or device groups allowing you to:

- Run tests automatically or in an interactive mode
- Repeat tests



- Display or save test results
- Run thorough tests to introduce additional test options to provide extra information about the failed device(s)
- View status messages that inform you if tests are completed successfully
- View error messages that inform you of problems encountered during testing

**NOTE:** Some tests for specific devices require user interaction. Always ensure that you are present at the computer terminal when the diagnostic tests are performed.

For more information, see [Dell EPSA Diagnostic 3.0](#).

## Running the ePSA diagnostics

- 1 Turn on your computer.
- 2 As the computer boots, press the F12 key as the Dell logo appears.
- 3 On the boot menu screen, select the **Diagnostics** option.
- 4 Click the arrow at the bottom left corner.  
Diagnostics front page is displayed.
- 5 Click the arrow in the lower-right corner to go to the page listing.  
The items detected are listed.
- 6 To run a diagnostic test on a specific device, press Esc and click **Yes** to stop the diagnostic test.
- 7 Select the device from the left pane and click **Run Tests**.
- 8 If there are any issues, error codes are displayed.  
Note the error code and validation number and contact Dell.

## System diagnostic lights

### Power and battery-status light/hard-drive activity light

Indicates the battery-charge status or the hard-drive activity.

**NOTE:** Press **Fn+H** to toggle this light between power and battery-status light and hard-drive activity light.

#### Hard-drive activity light

Turns on when the computer reads from or writes to the hard drive.

**NOTE:** Hard-drive activity light is supported only on computers shipped with hard drive.

#### Power and battery-status light

Indicates the power and battery-charge status

**Solid white** — Power adapter is connected and the battery has more than 5 percent charge.

**Amber** — Computer is running on battery and the battery has less than 5 percent charge.

#### Off

- Power adapter is connected and the battery is fully charged.
- Computer is running on battery and the battery has more than 5 percent charge.
- Computer is in sleep state, hibernation, or turned off

**NOTE:** Hard-drive activity light is supported only on computers shipped with hard drive.

The power and battery-status light blinks amber along with beep codes indicating failures.

For example, the power and battery-status light blinks amber two times followed by a pause, and then blinks white three times followed by a pause. This 2,3 pattern continues until the computer is turned off indicating no memory or RAM is detected.

The following table shows different light patterns and describes what they indicate.

**Table 16. Diagnostics**

Light pattern	Problem description
2,1	CPU failure
2,2	System board: BIOS and ROM failure
2,3	No memory or RAM detected
2,4	Memory or RAM failure
2,5	Invalid memory installed
2,6	System board or chipset error
2,7	LCD failure
3,1	CMOS battery failure
3,2	PCI or video card or chip failure
3,3	Recovery image not found
3,4	Recovery image found but invalid

**Camera status light:** Indicates whether the camera is in use.

- Solid white — Camera is in use.
- Off — Camera is not in use.

**Caps Lock status light:** Indicates whether Caps Lock is enabled or disabled.

- Solid white — Caps Lock enabled.
- Off — Caps Lock disabled.

## Wi-Fi power cycle

If your computer is unable to access the internet due to Wi-Fi connectivity issues a Wi-Fi power cycle procedure may be performed. The following procedure provides the instructions on how to conduct a Wi-Fi power cycle:

**NOTE:** Some ISPs (Internet Service Providers) provide a modem/router combo device.

- 1 Turn off your computer.
- 2 Turn off the modem.
- 3 Turn off the wireless router.
- 4 Wait for 30 seconds.
- 5 Turn on the wireless router.
- 6 Turn on the modem.
- 7 Turn on your computer.

## Flea power release

Flea power is the residual static electricity that remains on the computer even after it has been powered off and the battery has been removed. The following procedure provides the instructions on how to conduct flea power release:

- 1 Turn off your computer.
- 2 Disconnect the power adapter from your computer.

- 3 Press and hold the power button for 15 seconds to drain the flea power.
- 4 Connect the power adapter to your computer.
- 5 Turn on your computer.

# Getting help and contacting Dell

## Self-help resources

You can get information and help on Dell products and services using these self-help resources:

**Table 17. Self-help resources**

Information about Dell products and services

[www.dell.com](http://www.dell.com)

Dell Help & Support app



Tips



Contact Support

In Windows search, type `Contact Support`, and press Enter.

Online help for operating system

[www.dell.com/support/windows](http://www.dell.com/support/windows)

[www.dell.com/support/linux](http://www.dell.com/support/linux)

Troubleshooting information, user manuals, setup instructions, product specifications, technical help blogs, drivers, software updates, and so on.

[www.dell.com/support](http://www.dell.com/support)

Dell knowledge base articles for a variety of computer concerns.

- 1 Go to [www.dell.com/support](http://www.dell.com/support).
- 2 Type the subject or keyword in the **Search** box.
- 3 Click **Search** to retrieve the related articles.

Learn and know the following information about your product:

See *Me and My Dell* at [www.dell.com/support/manuals](http://www.dell.com/support/manuals).

- Product specifications
- Operating system
- Setting up and using your product
- Data backup
- Troubleshooting and diagnostics
- Factory and system restore
- BIOS information

To locate the *Me and My Dell* relevant to your product, identify your product through one of the following:

- Select **Detect Product**.
- Locate your product through the drop-down menu under **View Products**.
- Enter the **Service Tag number** or **Product ID** in the search bar.

## Contacting Dell

To contact Dell for sales, technical support, or customer service issues, see [www.dell.com/contactdell](http://www.dell.com/contactdell).

**NOTE:** Availability varies by country and product, and some services may not be available in your country.

**NOTE:** If you do not have an active internet connection, you can find contact information on your purchase invoice, packing slip, bill, or Dell product catalog.